

# Frontload Washer

Refer to Page 10 for Model Identification

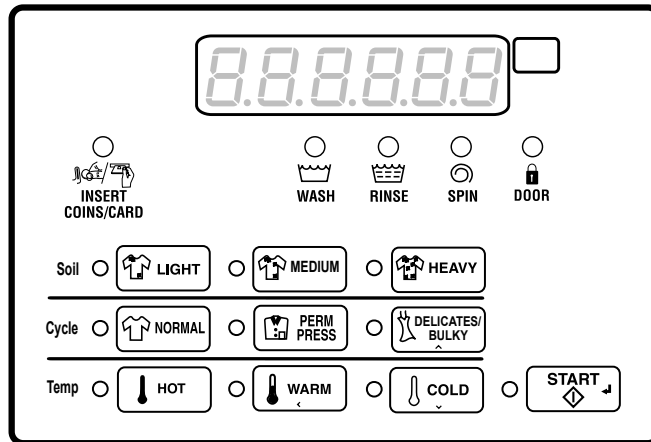

FLW1547C\_SVG

**Original Instructions**

Keep These Instructions for Future Reference.

**CAUTION:** Read the instructions before using the machine.

(If this machine changes ownership, this manual must accompany machine.)





## WARNING

Failure to install, maintain, and/or operate this machine according to the manufacturer's instructions may result in conditions which can produce bodily injury and/or property damage.

W030



## WARNING

For your safety and to reduce the risk of fire or an explosion, do not store or use gasoline or other flammable vapors and liquids in the vicinity of this or any other appliance.

W022

**NOTE: The WARNING and IMPORTANT instructions appearing in this manual are not meant to cover all possible conditions and situations that may occur. It must be understood that common sense, caution, and carefulness are factors which cannot be built into these washers. These factors MUST BE supplied by the person(s) installing, maintaining, or operating the unit.**

Always contact the distributor, service agent, or the manufacturer about any problems or conditions you do not understand.



Read all instructions before using unit.



Hazardous voltage inside. Disconnect power before servicing.

This product uses FreeRTOS V7.2.0 ([www.freertos.org](http://www.freertos.org)).

# Table of Contents

<b>Model Identification .....</b>	<b>10</b>
<b>Preliminary Information.....</b>	<b>12</b>
About the Control .....	12
Glossary of Terms.....	12
Power Failure Recovery.....	12
Communications.....	12
Infra-red Communications.....	12
Serial Card Reader Communications (Card Models Only).....	12
Network Communications.....	12
<b>Control Identification.....</b>	<b>13</b>
Select Cycle Pads .....	13
Select Wash Temp Pads.....	13
Select Cycle Modifier Pads.....	13
<b>Display Identification.....</b>	<b>14</b>
Light Emitting Diodes (LEDs).....	14
CYCLE LED.....	14
WASH TEMP LED.....	14
WASH LED.....	14
RINSE LED.....	14
SPIN LED.....	14
INSERT COINS/CARD LED.....	14
DOOR LED.....	14
LIGHT LED.....	14
MEDIUM LED.....	14
HEAVY LED.....	14
7-Segment Digits.....	14
<b>Washer Operation.....</b>	<b>15</b>
Power Up.....	15
Ready Mode.....	15
Partial Vend Mode.....	15
Additional Vend Mode.....	15
Start Mode.....	15
End of Cycle Mode.....	15
Door Locking Mode.....	15
Door Unlocking Mode.....	15
Cycle Sequence.....	15

© Copyright 2018, Alliance Laundry Systems LLC

All rights reserved. No part of the contents of this book may be reproduced or transmitted in any form or by any means without the expressed written consent of the publisher.

Closing Washer Door.....	16
Signals.....	16
Changing Cycles.....	16
Pause Mode.....	16
Delayed Start Setup (OPL Only).....	16
Delayed Start (OPL Only).....	16
Auto Flush Mode.....	17
Overflow Mode.....	17
Lockout Mode.....	17
Shutdown Mode.....	17
Power Failure Display Mode.....	17
<b>Special Features .....</b>	<b>18</b>
Programming Control.....	18
Collecting Audit Information.....	18
Testing Machine and Control Functions.....	18
Rapid Advance Feature.....	18
Clearing the Vend Feature .....	18
Communications Mode.....	18
Coin Drop.....	18
Start Pulse Operation.....	18
Service Door and Coin Vault Openings.....	18
Break-In Alarm.....	19
Special Vend.....	19
OPL Mode.....	19
Drop-Off Mode.....	19
Low Power/Auto-Shutdown Option.....	19
Out of Order Mode.....	19
Network Node Number Display Mode.....	19
Error Display Mode.....	19
<b>Opening the Service Door.....</b>	<b>20</b>
Stacked Washers and Dryers, 10 Degree Front Control Washers and Coin Rear Control Washers.....	20
Rear Control Washers with Card Reader.....	20
45 Degree Front Control Models.....	21
<b>Entering the Manual Mode.....</b>	<b>22</b>
How to Enter the Manual Mode.....	22
Manual Mode Navigation.....	22
<b>Programming Control.....</b>	<b>24</b>
What Can Be Programmed.....	24
Programmable Options Available .....	24
Vend Price 1 AtS 1.....	41
Vend Price 2 AtS 2.....	41
Vend Price 3 AtS 3.....	42
Vend Price 4 AtS 4.....	42
Vend Price 5 AtS 5.....	42

Vend Price 6 AtS 6.....	43
Vend Price 7 AtS 7.....	43
Vend Price 8 AtS 8.....	43
Vend Price 9 AtS 9.....	43
Cycle Modifier Key 1 MEDIUM Vend Price Adder ACNP 1.....	44
Cycle Modifier Key 2 HEAVY Vend Price Adder ACNP 2.....	44
Vend Price Decimal Point Ats dP.....	44
Coin 1 Value dEn 1.....	44
Coin 2 Value dEn 2.....	45
Start Pulse Value PLSE.....	45
Start Pulse Mode PLSNod.....	45
Programmable Output Type AtyPE.....	46
Default Cycle dFtCyC.....	46
Card Reader Display Control CARd.....	47
Audio Signal AUdio.....	47
How to Program the Audio Signal.....	47
How to Read Audio Signal Table.....	48
Network Node Number nodE.....	49
Error Code Programming Error-.....	49
Low Water Level FL Lo.....	52
Medium Water Level FL NEd.....	52
High Water Level FL Hi.....	53
Flush Out Time for Fill Step FLSH t.....	53
No Refill After Time for Agitate Step norF t.....	53
Set Real-Time Clock rtC-.....	53
Set Daylight Savings Time dLS-.....	54
Special Vend 1 Days Enable SP1 1.....	54
How to Read the Days Enable Value Table.....	55
How to Program Special Vend 1 Start Minute SP1 2.....	60
How to Program Special Vend 1 Start Hour SP1 3.....	60
How to Program Special Vend 1 Start Date SP1 4.....	60
How to Program Special Vend 1 Start Month SP1 5.....	60
How to Program Special Vend 1 Start Year SP1 6.....	61
How to Program Special Vend 1 Length in Hours SP1 7.....	61
How to Program Special Vend 1 End Date SP1 8.....	61
How to Program Special Vend 1 End Month SP1 9.....	61
How to Program Special Vend 1 End Year SP1 10.....	61
How to Program Special Vend 1 Vend Price 1 SP1 11.....	61
How to Program Special Vend 1 Vend Price 2 SP1 12.....	62
How to Program Special Vend 1 Vend Price 3 SP1 13.....	62
How to Program Special Vend 1 Vend Price 4 SP1 14.....	62
How to Program Special Vend 1 Vend Price 5 SP1 15.....	62
How to Program Special Vend 1 Vend Price 6 SP1 16.....	62
How to Program Special Vend 1 Vend Price 7 SP1 17.....	63
How to Program Special Vend 1 Vend Price 8 SP1 18.....	63
How to Program Special Vend 1 Vend Price 9 SP1 19.....	63
How to Program Special Vend 1 Wash Status Agitate Steps Added Minutes SP1 20.....	63
How to Program Special Vend 1 Wash Status Agitate Steps Subtracted Minutes SP1 21.....	63
How to Program Special Vend 1 Cycle Modifier Default Value SP1 22.....	64

How to Program Special Vend 1 Cycle Modifier MEDIUM Key #1 Vend Price SP1 23.....	64
How to Program Special Vend 1 Cycle Modifier HEAVY Key #2 Vend Price SP1 24.....	64
How to Program Special Vend 1 Cycle Modifier MEDIUM Key #1 Options SP1 25.....	64
How to Program Special Vend 1 Cycle Modifier HEAVY Key #2 Options SP1 26.....	64
How to Program Special Vend 1 Extract Speed Limit SP1 27.....	65
Special Vend 2 Days Enable SP2.....	65
Special Vend 3 Days Enable SP3.....	65
Special Vend 4 Days Enable SP4.....	65
Cycle Modifier Programming CNP-.....	66
How to Program Default Cycle Modifier CNP 1.....	66
How to Program Cycle Modifier MEDIUM Key #1 Options CNP 2.....	66
How to Program Cycle Modifier HEAVY Key #2 Options CNP 3.....	68
How to Program Cycle Modifier MEDIUM Additional Wash Time CNP 4.....	68
How to Program Cycle Modifier MEDIUM Additional Rinse Time CNP 5.....	69
How to Program Cycle Modifier HEAVY Additional Wash Time CNP 6.....	69
How to Program Cycle Modifier HEAVY Additional Rinse Time CNP 7.....	69
How to Enter Cycle Programming CyCLE-.....	70
Programming the Fill Step Type.....	72
Programming the Supply Step Type.....	73
Programming the Agitate Step Type.....	75
Programming the Soak Step Type.....	76
Programming the Drain Step Type.....	77
Programming the Extract Drain (Spin) Step Type.....	78
Programming the Audio Step Type.....	79
Programming the Hold Step Type.....	80
Hold Step Custom Messages CNESS-.....	81
Programmable Cycle Time Display PCyCtd.....	81
No Cycle Time Display nCyCtd.....	81
Number of Balance Attempts with No Loss of Time bAL At.....	81
Cycle Pause Resume CyCPAU.....	82
Low Power-Auto Shutdown 1 Days Enable LPAS 1.....	82
Low Power-Auto Shutdown 2 Days Enable LPAS 2.....	82
Low Power-Auto Shutdown 3 Days Enable LPAS 3.....	83
Low Power-Auto Shutdown 4 Days Enable LPAS 4.....	83
Power Fail Reset PF rst.....	83
How to Read Power Fail Reset Table.....	83
IR Access IrA En.....	83
Manual Rapid Advance rAPdEn.....	84
Manual Diagnostics diAgEn.....	84
Factory Test Ft En.....	84
Lucky Cycle LUC-.....	84
Speed Units SUnitS.....	85
Programmable Close Door Display PCdL.....	85
Programmable Push Start Display PPSt.....	85
Programmable Open Door Display PodL.....	86
Vend Price Display Override AtS do.....	86
OPL Parameters oPL-.....	86

OPL Mode Enable oPL 1.....	86
OPL Delayed Start oPL 2.....	87
OPL Display Power Save oPL 3.....	87
Drop Off Mode droP.....	87
Out of Order oUt.....	87
<b>Collecting Audit Information.....</b>	<b>89</b>
How to Enter Audit Feature.....	89
Entering the Audit Feature by Manual Mode.....	89
Entering the Audit Feature with the Coin Vault Open.....	89
How to Read Audit Data.....	89
How to Exit Audit Feature.....	89
<b>Manual Reset.....</b>	<b>90</b>
How to Enter Manual Reset .....	90
<b>Testing Machine and Electronic Control Functions.....</b>	<b>91</b>
How to Enter Testing Feature.....	91
How to Start Tests.....	91
How to Exit Testing Feature .....	91
Diagnostic (Testing) Mode – Quick Reference Chart.....	91
Diagnostic Test Descriptions.....	93
Control Software Version Number Test d 1.....	94
Drive Board #1 Software Test d 3.....	94
Water Level Trim Test d 7.....	94
Service Door Opening Test d 8.....	94
Coin Vault Opening Test d 9.....	94
Coin Drop 1 Input Test d 10.....	94
Coin Drop 2 Input Test d 11.....	94
Vend Connection Header Present Test d 12.....	94
Start Pulse Test d 13.....	94
Door Switch Input Test d 15.....	95
Door Lock Input Test d 16.....	95
Show Fill Time Test d 17.....	95
Show Drain Time Test d 18.....	95
Out of Balance Switch Test d 22.....	95
External Outputs Test d 23.....	95
Water Purge Test d 24.....	95
Water Leak Detection Test d 25.....	95
Water Level Test d 26.....	96
DC Bus Voltage Test d 27.....	96
AC Mains Voltage Test d 28.....	96
Configuration 1 Display Test d 29.....	96
Configuration 2 Display Test d 30.....	99
Configuration 3 Display Test d 31.....	99
Configuration 4 Display Test d 32.....	99
Configuration 5 Display Test d 33.....	100
Factory Test.....	100
To Enter Factory Test.....	100



To Exit Factory Test.....	101
.....	101
<b>Error Codes .....</b>	<b>104</b>
<b>Rapid Advance Feature.....</b>	<b>111</b>
How to Enter Rapid Advance.....	111
How to Exit Rapid Advance Feature.....	111
<b>Clear Vend Feature.....</b>	<b>112</b>
How to Clear Vend.....	112
<b>Power Fail Recovery.....</b>	<b>113</b>
<b>Communications Mode.....</b>	<b>114</b>
Infra-red Communications.....	114
How to Begin Communications with an External Device.....	114
Card Reader Communications - Card Models Only.....	114
Network Communications.....	114
<b>Default Cycle Time .....</b>	<b>115</b>

# Model Identification

Information in this manual is applicable to these washer models:

HFNNEASP113CW01	SFNNNEASP113CW01	SFNWCASG115TN01	STENYFSP175TW01
HFNNEASP115CW01	SFNNNEASP115CW01	SFNWCASP113TN01	STEWXCASP175TW41
HFNNERSP113CW01	SFNNERSP113CW02	SFNWCASP115TN01	STEWCFSP175TW41
HFNNERSP115CW01	SFNNERSP115CW02	SFNWCASP115TW41	STEWXCASP173TW01
HFNNXASP113CN01	SFNNXAJP113CN01	SFNWCRSP115TW42	STEWXCASP175TW01
HFNNXASP113CW01	SFNNXAJP115CN01	SFNWXASP113TW01	STEWXCASP285CW01
HFNNXASP115CN01	SFNNXASG113JW01	SFNWXASP115TW01	STEWXCASP295CW01
HFNNXASP115CW01	SFNNXASG113TW01	SFNWXRSP113TW02	STEWXCASP453NN22
HFNNXASP123DW01	SFNNXASG115TW01	SFNWXRSP115TW02	STEWYASP173TW01
HFNNXASP543DW01	SFNNXASG303AN12	SFNWYASG113TN01	STEWYASP175TW01
HFNNXRSP113CW01	SFNNXASG303AW12	SFNWYASG115TN01	STEWYASP175TW41
HFNNYASP113CW01	SFNNXASP113CN01	SFNWYASP113TN01	STGNCASP113TW01
HFNNYBSP113CW01	SFNNXASP113CW01	SFNWYASP113TW01	STGNCASP115TW01
HFNNYRSP113CW01	SFNNXASP113TN01	SFNWYASP115TN01	STGNCFSP113TW01
HTENXASP133DW01	SFNNXASP113TW01	SFNWYASP115TW01	STGNCFSP115TW01
HTENXASP283CW01	SFNNXASP115CN01	SFNWYASP115TW41	STGNEASP093CW01
HTENXASP285CW01	SFNNXASP115CW01	SFNWYRSP113TW01	STGNEASP095CW01
HTENXASP293CW01	SFNNXASP115TN01	SFNWYRSP115TW01	STGNXASG083JW01
HTENXASP295CW01	SFNNXASP115TW01	SFNWYRSP115TW41	STGNXASG113JW01
HTENXASP543DW01	SFNNXASP123DW01	STENCASP173TW01	STGNXASG113TW01
HTENYASP283CW01	SFNNXASP303AN01	STENCASP175TW01	STGNXASG115TW01
HTENYASP285CW01	SFNNXASP303AN12	STENCFSP173TW01	STGNXASP093CW01
HTENYASP293CW01	SFNNXASP303AW01	STENCFSP175TW01	STGNXASP095CW01
HTENYASP295CW01	SFNNXASP303AW12	STENEASP283CW01	STGNXASP113TW01
HTGNXASP093CW01	SFNNXASP303NN26	STENEASP285CW01	STGNXASP115TW01
HTGNXASP095CW01	SFNNXASP543DW01	STENEASP293CW01	STGNXASP123DW01
HTGNXASP123DW01	SFNNXASP543RW01	STENEASP295CW01	STGNXASP303AW01
HTGNXASP543DW01	SFNNXRSP113CW02	STENXASP133DW01	STGNXASP303AW12
NFNJXASP543NN23	SFNNXRSP113TW02	STENXASP173TW01	STGNXASP543DN01
NFNJYASP543NN23	SFNNXRSP115CW02	STENXASP175TW01	STGNXASP543DW01
SFNNCAJP113TW01	SFNNXRSP115TW02	STENXASP283CW01	STGNXFSP113TW01

Table continues...

SFNNCAJP115TW01	SFNNXRSP543NW23	STENXASP285CW01	STGNXFSP115TW01
SFNNCASG113TN01	SFNNYAJP113TW01	STENXASP293CW01	STGNYASP093CW01
SFNNCASG113TQ01	SFNNYAJP115TW01	STENXASP295CW01	STGNYASP095CW01
SFNNCASG113TW01	SFNNYASG113TN01	STENXASP433AW01	STGNYASP113TN01
SFNNCASG115TN01	SFNNYASG113TW01	STENXASP433AW12	STGNYASP113TW01
SFNNCASG115TQ01	SFNNYASG115TN01	STENXASP433LW01	STGNYASP115TN01
SFNNCASG115TW01	SFNNYASG115TW01	STENXASP543DN01	STGNYASP115TW01
SFNNCASP113TN01	SFNNYASP113CW01	STENXASP543DW01	STGNYFSP113TW01
SFNNCASP113TQ01	SFNNYASP113TN01	STENXASP543RW01	STGNYFSP115TW01
SFNNCASP113TW01	SFNNYASP113TW01	STENXFSP173TW01	STGNZASP113NW22
SFNNCASP115TN01	SFNNYASP115CW01	STENXFSP175TW01	STGWCASP115TW41
SFNNCASP115TQ01	SFNNYASP115TN01	STENYASP173TN01	STGWCASP115TW41
SFNNCASP115TW01	SFNNYASP115TW01	STENYASP173TW01	STGWCASP095CW01
SFNNCRSP113TW01	SFNNYBSP113TN01	STENYASP175TN01	STGWCASP113TW01
SFNNCRSP113TW02	SFNNYBSP113TW01	STENYASP175TW01	STGWCASP115TW01
SFNNCRSP115TW02	SFNNYBSP115TN01	STENYASP283CW01	STGWCASP113TW01
SFNNEASG113CN01	SFNNYBSP115TW01	STENYASP285CW01	STGWCASP115TW01
SFNNEASG113CW01	SFNNYRSP113TW01	STENYASP293CW01	STGWCASP115TW41
SFNNEASG115CN01	SFNNYRSP115TW01	STENYASP295CW01	STLNXPASP303LW01
SFNNEASG115CW01	SFNWCASG113TN01	STENYFSP173TW01	STLNYPASP543PW01
			STLWPASP303NN22

# Preliminary Information

## About the Control

This control is an advanced, programmable computer that lets the owner control most machine features by pressing a sequence of keypads.

The control allows the owner to program custom cycles, set vend prices, retrieve audit information, run diagnostic tests, program special vend features and set other programmable features. Washers shipped from the factory have a default cycle setting of NORMAL COLD built in. However, the owner can change the default cycle, or any cycle, as needs permit.

**IMPORTANT: In the event of a power failure, the control will not have to be reprogrammed. It is designed with a memory system that will remember how it was programmed until the electrical power is restored.**

**IMPORTANT: It is extremely important that the washer has a good ground connection and that all mechanical and electrical connections to the control are made before applying power to or operating the washer.**

## Glossary of Terms

The following are a few terms and abbreviations to learn. These are referred to throughout the instructions.

Display – This term refers to the window area of the control that displays words and values.

LED (Light Emitting Diode) – This term refers to the lights next to the keypads and status words of the control.

IrDA – Infra-red External Device

FEC – Front End Control

I/O Board – Input/Output Board

OPL – On Premises Laundry

## Power Failure Recovery

If a cycle is in progress and the power fails, the cycle status is saved in memory. When the power recovers, the washer will resume into the previously active cycle if so programmed by the owner.

The owner may program a special feature called POWER FAIL RESET which sets a maximum power failure duration. To program this feature, refer to *Programming Control*.

If the length of the power failure is greater than the POWER FAIL RESET time, the control will end the cycle and the display will revert back to the ready mode.

On drain pump models, if the wash basket is full of water, the control will lock the door and pump out the water.

## Communications

The control may be programmed manually, by infra-red with an external device or by a network. A limited number of features can be programmed by a card reader.

### Infra-red Communications

An external device, such as a PDA, allows the owner to program and retrieve information from the control without touching the keypad. An external device greatly expands the programming options available to the owner. However, the external device is not required to program and operate the machine. The operation of an external device and the advanced features available are covered separately in the instructions included with the external device software. Contact Alliance Laundry Systems for a list of approved PDAs and other external devices.

### Serial Card Reader Communications (Card Models Only)

The control will accept communication with a serial card reader in order to perform vending transactions when a card is inserted to pay for cycles. The card reader can also allow the owner to program a limited number of features and collect audit information.

For detailed information on serial card reader communications, refer to instructions included with card reader.

### Network Communications

The control will also accept communication with a network interface board which allows the control to be linked to a personal computer. This network link allows an owner to program, collect data and run diagnostics on any machine.

For detailed information on network communications, refer to the network instructions.

# Control Identification

## Select Cycle Pads

SELECT CYCLE pads are used to select the specific washer cycle. These pads include NORMAL, PERM PRESS, and DELICATES/BULKY. These pads allow the user to select a cycle other than the default cycle (Normal Cold). The SELECT CYCLE key-pads are not active after the first fill step of the cycle. The selected cycle is indicated by the light (LED) on the pad. Pressing the flashing START pad will confirm the selection and the cycle will begin. When the card reader is used, pressing the START pad will start the cycle and deduct the vend price from the card.

## Select Wash Temp Pads

SELECT WASH TEMP pads are used to select the temperature of the water used for the wash fill. These pads include HOT,

WARM, and COLD. These pads allow the user to select a water temperature other than the default setting (COLD).

**NOTE: Cycles are picked by selecting a Soil, Cycle and Temp pad.**

## Select Cycle Modifier Pads

The Cycle Modifier pads are used to select cycle modifier options. The LIGHT option is the default and indicates no cycle modifiers are active. The MEDIUM and HEAVY options can be programmed to offer extra features for an added vend price. Features available include an added prewash, extra wash time, an added extra rinse, extra rinse time and a warm rinse temperature.

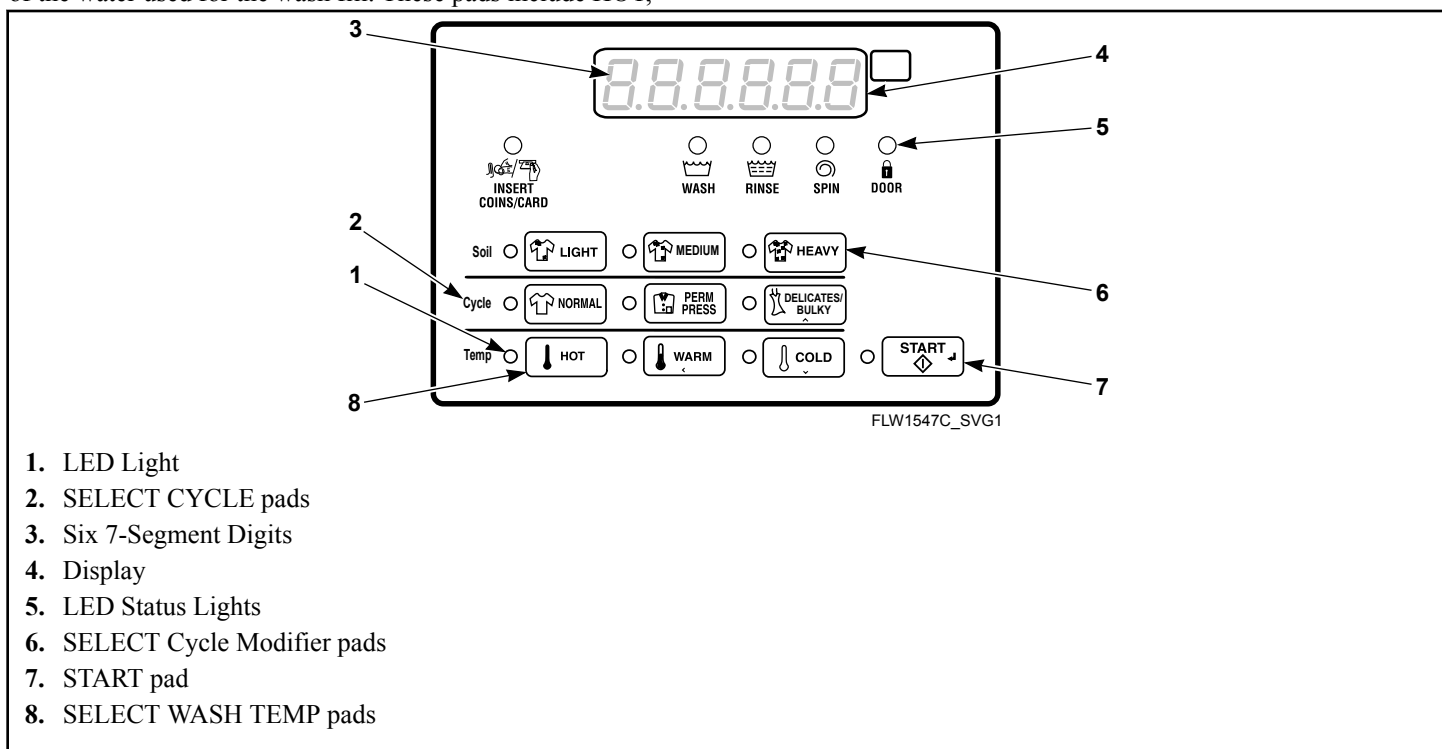

1. LED Light
2. SELECT CYCLE pads
3. Six 7-Segment Digits
4. Display
5. LED Status Lights
6. SELECT Cycle Modifier pads
7. START pad
8. SELECT WASH TEMP pads

Figure 1

# Display Identification

## Light Emitting Diodes (LEDs)

LIGHT EMITTING DIODES (LEDs) are used to indicate the chosen cycle and cycle status. See below for information on each LED.

### **CYCLE LED**

CYCLE LED will remain lit the entire cycle.

### **WASH TEMP LED**

WASH TEMP LED will remain on until the end of the cycle or will change to show the rinse temperature if programmed to do so.

### **WASH LED**

WASH LED is lit at the beginning of a wash portion of the cycle and will remain lit until the wash is complete.

### **RINSE LED**

RINSE LED is lit at the beginning of a rinse portion of the cycle and will remain lit until the rinse is complete.

### **SPIN LED**

SPIN LED is lit during the Final Spin portion of the cycle.

### **INSERT COINS/CARD LED**

INSERT COINS/CARD LED prompts the user for coins or a card to satisfy the vend price. The six digits show the vend price remaining to be satisfied. The vend price displayed will decrease with each coin inserted. If new options are selected before the first fill step of the wash cycle completes and it requires additional vend, the INSERT COINS/CARD light will flash one (1) second on and one (1) second off, and the display will flash the vend price remaining to be satisfied one (1) second on/off.

### **DOOR LED**

DOOR LED is lit whenever the door is locked. The door can't be opened when this LED is lit.

### **LIGHT LED**

LIGHT LED is lit when the Option LIGHT modifier is selected.

### **MEDIUM LED**

MEDIUM LED is lit when the Option MEDIUM modifier is selected.

### **HEAVY LED**

HEAVY LED is lit when the Option HEAVY modifier is selected.

## 7-Segment Digits

The 7-SEGMENT DIGITS are used to display the time remaining in a cycle, vend price, error messages and descriptive codes. During diagnostic testing or manual programming of the control, these digits will display descriptive codes and values.

# Washer Operation

## Power Up

When power is applied to the washer, the control will display its control type as *FL*, software version as *5HHH* (*HH* is the version number) for one (1) second each. If the control was not powered down during a running cycle, it will enter the Ready Mode.

## Ready Mode

In this mode of operation, the display shows the current selected cycle, modifier, temperature and the full current vend price for that cycle. The INSERT COINS/CARD LED is lit.

To start the cycle, the user must satisfy the vend price and then press the START keypad.

The user will be able to select a different cycle/wash water temperature or modifier by pressing a cycle pad when the machine is in the ready mode or before the first fill is complete.

## Partial Vend Mode

The control enters this mode when part of the vend price has been entered, but not enough vend is entered to satisfy the vend price. The control will display the remaining vend price needed to start the cycle and the INSERT COINS/CARD LED is lit.

## Additional Vend Mode

The control enters this mode if a change is made before the first fill is complete. If the vend price is not satisfied within one (1) minute, the washer control will go back to the first selection and the cycle will continue. Pressing the START keypad will cancel cycle changes and exit this mode. After the first fill, all key presses will be ignored, allowing the washer to go through the complete cycle.

## Start Mode

The control enters this mode when the full vend price is satisfied, the vend price is zero, or the control is in OPL Mode. The START pad LED will flash one (1) second on and one (1) second off. If Start Mode is entered because the vend price is satisfied or the control is in OPL Mode, the display will show *PUSH* for one (1) second, *START* for one (1) second and the current cycle time for one (1) second. If Start Mode is entered because the vend price is zero (0), the display will show *FREE*. When first entering Start Mode, a signal will sound for one (1) second on and one (1) second off for 10 seconds if Signal for Start is enabled.

After pressing the START keypad, the door will lock and the cycle will begin.

## End of Cycle Mode

When a cycle is complete, the control will display *00* until the washer is opened, a key is pressed, or a coin/card is entered. When one of these three options occurs, the display will revert back to the ready mode.

## Door Locking Mode

The control enters this mode after the Start pad is pressed in Start Mode or Pause Mode to start or resume a machine cycle. The control will stay in Door Locking Mode until the loading door is closed and locked. The control shows the remaining cycle time and the Door Lock LED flashes one second on/off.

Once the door is locked, the control will exit Door Locking Mode and will enter Run Mode. If the door is opened prior to being locked, the control will return to Start Mode.

## Door Unlocking Mode

This mode is entered when there is no time left in the cycle or when pausing the cycle while in Run Mode. The door will unlock after the basket stops spinning. The display will continue to flash the remaining cycle time every second or if the next mode is End of Cycle Mode, it will flash *01* every second. If the next mode is Pause Mode, the display will flash *PAUSE* every second. If the drive board determines that the water temperature is too hot to drain or unlock the door, the display will flash *Hot* in addition to the other displays.

The machine will always drain water down to an empty level before attempting to unlock the door. If after the programmed time of draining, the water level is still not low enough, the control will enter Machine Error Mode with a drain error, if enabled. Otherwise the control will continue to drain until it sees the machine empty.

The Start key can be pressed while in this mode as long as Machine Error Mode or End of Cycle Mode is not the next mode. If the Start key is pressed and the next mode is Pause Mode or Start Mode, the next mode entered will be Door Locking Mode. Otherwise the press is invalid. All other keys are invalid while in this mode. Once Door Unlocking Mode is exited, the control will enter the next mode.

## Cycle Sequence

Upon the start of a cycle, the control will display the total cycle time. The appropriate LEDs will light while the machine passes through different cycle steps. Any coin entered after the first fill completes will be added to the total coin counter, but the user will not be able to change cycles.

## Closing Washer Door

If the door is not closed when the vend price is satisfied, **CLOSE** and **door** will be displayed until the door is closed. Once door is closed, the START pad must be pressed to lock door and start the cycle. If the door does not lock within 20 seconds of being closed, **ERROR** will be displayed, indicating a door lock error, while the door continues to try to lock.

If the door locks after 20 seconds, the door lock error will clear and the cycle will continue normally. The door can be opened to clear the door lock error as well.

## Signals

There are five options when a signal can be used during the washer operation. These five options are listed below:

1. **End of Cycle Signal** By default, this signal is turned off. If turned on, the signal sounds for three (3) seconds at the end of a cycle.
2. **Signal On Keypad Depression** By default, this signal is turned on and sounds for a quarter of a second each time a keypad is pressed.
3. **Signal On Coin Input/Card Insertion** By default, this signal is turned on and will sound for a quarter of a second each time a coin or card is entered.
4. **Signal for Serial or Network Vending Command** By default, this signal is turned on for a quarter of a second when the control receives a valid serial or network vend command.
5. **Signal for Start** By default, this signal is turned on and will sound one (1) second on and one (1) second off for 10 seconds after vend price has been satisfied.

**NOTE: Refer to *Programming Control* to program signal options.**

## Changing Cycles

Cycles and wash temperature can be changed before the first fill is complete. After the first fill, all key presses are ignored.

Selecting a higher priced cycle/wash temperature or modifier will pause the first fill step, and INSERT COINS/CARD LED will flash one (1) second on and one (1) second off until the vend price has been satisfied. After the vend price has been satisfied, the cycle will continue with the new selections. If the vend price is not satisfied within one (1) minute, the washer control will go back to the previously set cycle/wash temperature and modifier.

## Pause Mode

Pause Mode is entered when the START pad is pressed three times within 5 seconds during the first 3 minutes of a running machine cycle. This mode is only manually accessible if the Pause/Resume Mode (Enable/Disable) parameter is programmed to Enabled and if the control is in Run Mode or Door Locking Mode.

If this mode is entered the control will pause the cycle, enter Door Unlocking Mode, and drain/pump the water out. After the machine is confirmed to be empty and not rotating, the control will unlock the door. The control will then enter Pause Mode. The user may then restart the machine by pressing the START pad, where the machine will enter Door Locking Mode and once the door locks, the cycle will resume from where it left off.

**NOTE: The display will show *PUSH* and *Start*, the Cycle Selection LEDs will be lit, and if the door is locked, the door lock LED will be lit.**

## Delayed Start Setup (OPL Only)

Delayed Start Setup Mode is entered by holding any key except for the START key for 5 seconds while in Start Mode. To prevent changing the selected cycle and options, the user should press and hold one of the actively selected keys.

The door must be closed in order to enter this mode.

This mode is only manually accessible if the Delayed Start Mode (Enable/Disable) parameter is programmed to Enabled. While in the Delayed Start Setup Mode, pressing the DELICATES/BULKY (A) or the COLD (V) keypads will alter the number of hours the cycle is delayed up to a maximum of 72 hours. The time will loop around when the maximum or minimum value is reached. The display will show **HH Hr5** while modifying time or **01 Hr** if 1 hour is set and this display will toggle 1 second on and 1 second off.

If the door is opened while trying to program the delayed start time, the control will exit this mode and go back to Start Mode.

## Delayed Start (OPL Only)

Delayed Start is entered by pressing the Start keypad while in Delay Start Setup Mode. This mode is only manually accessible if the Delayed Start Mode (Enable/Disable) parameter is programmed to Enabled. The OPL Delay Start programming parameter can be programmed through IrDA and Network commands. The display will show **HH Hr5** toggled with **DELAY** every 1 second while counting down the hours. The display will show **HH Min** toggled with **DELAY** every 1 second once the time is 1 hour or less (would transition from **02 Hr5** to **00 Min**). The display will count down one hour or minute at a time showing a leading zero for one digit numbers.

Once the countdown time has expired or if the Start key is pressed while counting down delayed start time, the control will enter Door Locking Mode to begin the cycle. Cycle selection related LEDs will be lit while in this mode.

This mode can be exited by pressing the Back keypad which will then place the control into Start Mode.

If the door is opened at any point while in this mode, Delayed Start Mode will be exited and the control will enter Start Mode.



## Auto Flush Mode

The Auto-Flush Mode is only available if enabled in the Control Configuration. The programmable Auto-Flush option allows the control to be set to automatically flush the dispenser compartments at predetermined intervals and times. The option may be enabled or disabled. Auto Flush is entered if the following conditions are met.

1. It must be enabled in the Programming Parameters.
2. The machine is in Ready Mode, Start with OPL Mode Active and not in Power Recovery, or Shut-Down Mode with the door closed.
3. The pre-programmed number of cycles have occurred since the last Auto-Flush.
4. The current day-of-week matches the programmed day-of-week.
5. The current hour matches the programmed hour.

If these conditions are met, then the control will flush the dispenser compartments with hot water for a pre-programmed number of seconds (factory default is 30 seconds) or until the pressure sensor senses water up to the door level.

## Overflow Mode

If the control isn't running a cycle, is not in Door Locking Mode or Door Unlocking Mode, the overflow level is set at 6 inches. In Overflow Mode, if the door is closed, the door will lock, the pump will turn on, and the gravity drain will open until the water level is below the overflow reset level if running a cycle, otherwise the machine will drain until the drum is seen empty.

If Overflow Mode Display is disabled and the control will enter Run Mode when it exits, the display will show the default Run Mode display, otherwise in all other cases, the display will show **oFLo**. If the door locks and the overflow level is no longer being met within five (5) minutes of first detecting the overflow, the cycle will continue as normal and the control will go back to the mode it was previously in. If the control continues to see an overflow error after five (5) minutes has been reached with the door locked, the control will enter Machine Error Mode with an Overflow Error.

## Lockout Mode

If enabled in the Control Configuration, Lockout Mode is entered to prevent the machine from being used except by a particular user who has reserved the machine in advance. This mode is entered when the current time (in Hours and Minutes) falls within the time period set by the Lockout Mode Start Time Hour, Lockout Mode Start Time Minute, Lockout Duration, and when the control is in Ready Mode. The display will show **LES**. User access is ignored until Lockout Mode is exited. The control will be able to communicate with the Network, IR, or the Serial Payment System.

When entering the sequence of keypresses to exit Lockout Mode, pressing the START keypad signals the end of the keypress sequence. As each keypad is pressed the corresponding LED is lit. Anytime the START keypad is pressed the correct number of keys entered is verified and if not equal to four (4) the keypad sequence will be reset, all LED's will be turned off, and keypresses will be ignored for five (5) seconds while remaining in Lockout Mode. In addition, if five (5) keypads are pressed before the START keypad is pressed, the sequence will be reset, all LED's will be turned off, and keypresses will be ignored for five (5) seconds while remaining in Lockout Mode.

When the correct sequence of keypresses has been entered the control will enter Ready Mode. If the network programs the duration to zero, Lockout Mode will be exited.

## Shutdown Mode

Shutdown Mode is entered if a Low Power/Shutdown Option (1, 2, 3, or 4) becomes active with the Shutdown option enabled. To become active, the Low Power/Shutdown Option must be enabled in the Control Configuration and the current time, day-of-week, date, month, and year must match the programmed start requirements for the triggering Low Power/Shutdown Option.

If the control is in ready mode, drop-off mode, lockout mode, or start mode when no vend has been entered, shutdown mode can be entered. Shutdown Mode will automatically exit if the current time, day-of-week, date, month, and year satisfy an exit condition for the active Low Power/Shutdown Option. While in Shutdown Mode, the control will show **oFF** and all LEDs will be turned off.

Shutdown Mode can be exited by disabling the triggering Low Power/Shutdown Option (1, 2, 3, or 4) through Network and IR-DA commands. In addition, the Low Power/Shutdown Option (1, 2, 3, or 4) can be disabled using manual programming.

## Power Failure Display Mode

In Power Failure Display Mode the control will show **P\_rFA IL**. This informs the user that a cycle was interrupted and did not complete normally. This mode is entered from Power-Up Mode if a power failure occurred during an OPL cycle and the cycle is not able to automatically resume. If the user presses any key, Start Mode is entered.

# Special Features

## Programming Control

The control allows the owner to program the control with the use of the keypad. Cycle and vend information may be programmed, audit information may be viewed and diagnostic tests may be run by pressing keypad combinations.

## Collecting Audit Information

The control stores audit information in its memory that can be retrieved by pressing various combinations of Select Cycle pads.

For more information on the audit features, refer to *Collecting Audit Information*.

**NOTE: Additional audit information is retrievable with an external device, the card reader and the network. Refer to the appropriate instruction manual.**

## Testing Machine and Control Functions

Special diagnostic features built into the control allow the owner to run specific diagnostic tests. By opening and closing the service door and then pressing various sequences of Select Cycle pads, the owner may perform the following tests:

- Control Software Version # Test
- Drive Board #1 Software Version Test
- Service Door Switch Input Test
- Coin Vault Switch Input Test
- Coin Drop #1 Input Test
- Coin Drop #2 Input Test
- Vend Connection Header Present Input Test
- Start Pulse Input Test
- Door Switch Input Test\*
- Door Lock Switch Input Test\*
- Show Fill Time Test
- Show Drain Time Test
- Out of Balance Switch Input Test
- External Output Test\*
- Water Purge Test\*
- Water Leak Detection Test\*
- Water Level Test
- DC Bus Voltage Test
- AC Mains Voltage Test
- Machine Configuration #1 Display Test
- Machine Configuration #2 Display Test
- Machine Configuration #3 Display Test
- Machine Configuration #4 Display Test
- Machine Configuration #5 Display Test

\* Tests can only be entered when in Start or Ready Mode.

For detailed information on running diagnostic tests, refer to *Testing Machine and Electronic Control Functions*.

## Rapid Advance Feature

This feature allows the user to quickly advance through an active cycle or advance into a cycle from the Ready Mode. This feature is useful when tests must be performed immediately on a machine currently in an active cycle. In this case, the user can quickly advance through the cycle to the Ready Mode. At this point, the user can perform the required tests and then return the machine to the active cycle.

## Clearing the Vend Feature

This feature allows the user to return the control back to the Ready Mode if coins have been entered but the full vend price has not yet been satisfied, while in Partial Vend Mode.

For more information on using the Clear Vend feature, refer to *Clear Vend Feature*.

## Communications Mode

This feature allows the machine control to communicate with an external device, the card reader, or the network. This allows the washer control to be programmed and have its data read without using the keypad.

For more detailed information on using the Communications Mode feature, refer to *Communications*.

## Coin Drop

The control will accept pulses from a single or dual coin drop to satisfy vend price. Each coin drop will have the ability to satisfy the vend.

## Start Pulse Operation

The control will accept pulses from optional payment systems. The machine can be programmed to receive a single start pulse or multiple start pulses, or the Start Pulse Option can be turned off. The Start Pulse Mode allows the machine to go from the Ready Mode to the Start Mode after a single or multiple pulses are received.

## Service Door and Coin Vault Openings

The control will capture the times and dates of the last seven openings of the Coin Vault and the Service Door. The information is saved in memory. An open service door and a closed coin vault combined with various keypad presses allows the control to enter manual modes of operation if the Break-In Alarm is not on. These modes include Manual Programming, Audit Collection, Diagnostics, Rapid Advance, and Reset to Factory Defaults.

## Break-In Alarm

This feature allows the owner to program the machine to signal a network alarm, cause a machine alarm or shut down the machine if the service door or coin vault is opened without disabling the alarm first. The date and time of the break-in is recorded. To avoid the alarm during coin collections, the alarm must be turned off or temporarily disabled by pressing the two programmed keys.

The alarm is turned off by default. The alarm can be turned on by programming the control with an external device or network.

## Special Vend

This feature allows the owner to program the control to allow programmable vend prices for specific hours and dates.

For details on programming Special Vend, refer to *Programming Control*.

## OPL Mode

This feature allows the user to start a cycle without satisfying the vend price.

For details on enabling OPL Mode, refer to *Programming Control*.

## Drop-Off Mode

This feature allows the owner to limit machine use to an attendant without requiring vend. Starting the machine will require the correct sequence of four keypad presses followed by the START key as programmed by an external device. These keys can be programmed by an external device and are defaulted as modifier LIGHT, modifier MEDIUM, modifier HEAVY and NORMAL.

For details on enabling Drop-Off Mode, refer to *Programming Control*.

## Low Power/Auto-Shutdown Option

This feature allows the owner to program the control to shut down or enter a low power consumption mode based on programmable times and dates if either of these options are enabled.

For details on programming the Low Power/Auto-Shutdown option, refer to *Programming Control Low Power/Auto Shutdown 1 Days Enable LPAS 1*.

## Out of Order Mode

This feature allows the owner to program Out of Order Mode which can be used to show the owner that the machine is not available to use. The control will accept coins and increment the appropriate audit counters but the vend entered will not count towards a cycle purchase, the coin audio will not work, and no cycle will run while Out of Order Mode is active.

Refer to *Out of Order oUt*.

## Network Node Number Display Mode

This feature allows the owner to program a command via IrDA or network that requests the control to display the network node number. The control will display  $nHHH$  where  $HHH$  is the network node number.

## Error Display Mode

This feature is used to display a machine error. Only one error will be displayed at the time if there are multiple errors. Once the highest priority error is cleared, the next highest priority error will be displayed if multiple errors exist. Refer to *Error Codes* for more details on errors, their displays, and their priorities.

# Opening the Service Door

## Stacked Washers and Dryers, 10 Degree Front Control Washers and Coin Rear Control Washers

### Models through Serial No. 1810000001

Manual programming requires the user to open and close the service door. Opening and closing the service door trips a switch allowing access to various programming options, diagnostics, and audit capabilities. On coin models, the coin vault switch must be closed to enter Manual Mode.

### Models starting Serial No. 1810000001

Manual programming requires the user to unplug the bullet connector located between the “white/black” and “red/blue” wires. Reconnect the connector for normal operation.

After opening and closing the service door or unplugging the bullet connector, the programmer has 4.25 minutes to begin programming. If a keypad has not been pressed in that time, the control will revert back to the Ready Mode. Refer to *Figure 2*.

The service door is located in the control panel on the Stacked Washer and Dryers and Front Control Washers. On Rear Control Washers, the service door is located on the top of the meter case. Refer to *Figure 2*.

**NOTE: If the Break-In Alarm option is enabled, it must be turned off or disabled by pressing the two programmed keys before opening service door. For more information on using the Break-In Alarm, refer to the external device or network software instructions.**

## Rear Control Washers with Card Reader

Manual programming requires the user to remove the control panel and unplug the bullet connector located between the “white/black” and “red/blue” wires. This will allow the user to access various programming options, diagnostics, and audit capabilities. Refer to *Figure 2*.

## 45 Degree Front Control Models

Manual programming requires the user to remove the cabinet top or control panel and unplug the bullet connector located between the “white/black” and “red/blue” wires. This will allow the user to access various programming options, diagnostics, and audit capabilities. Refer to *Figure 3*.

1. Remove the screws from the back of the top panel that attach the top panel to the machine.
2. From the back of the machine, using a screwdriver, pry the top panel upward and towards you.
3. Remove the screws from the top of the control panel that attach the control panel to the machine.
4. Remove the screws from the bottom of the control panel that attach the control panel to the machine.

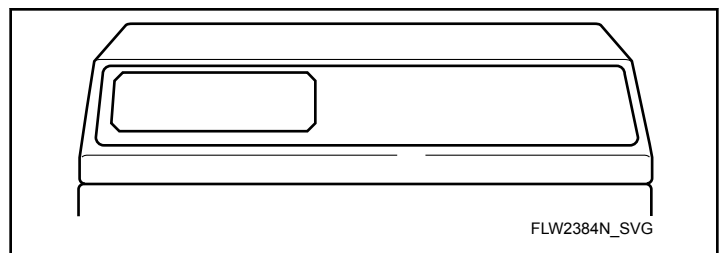

Figure 3

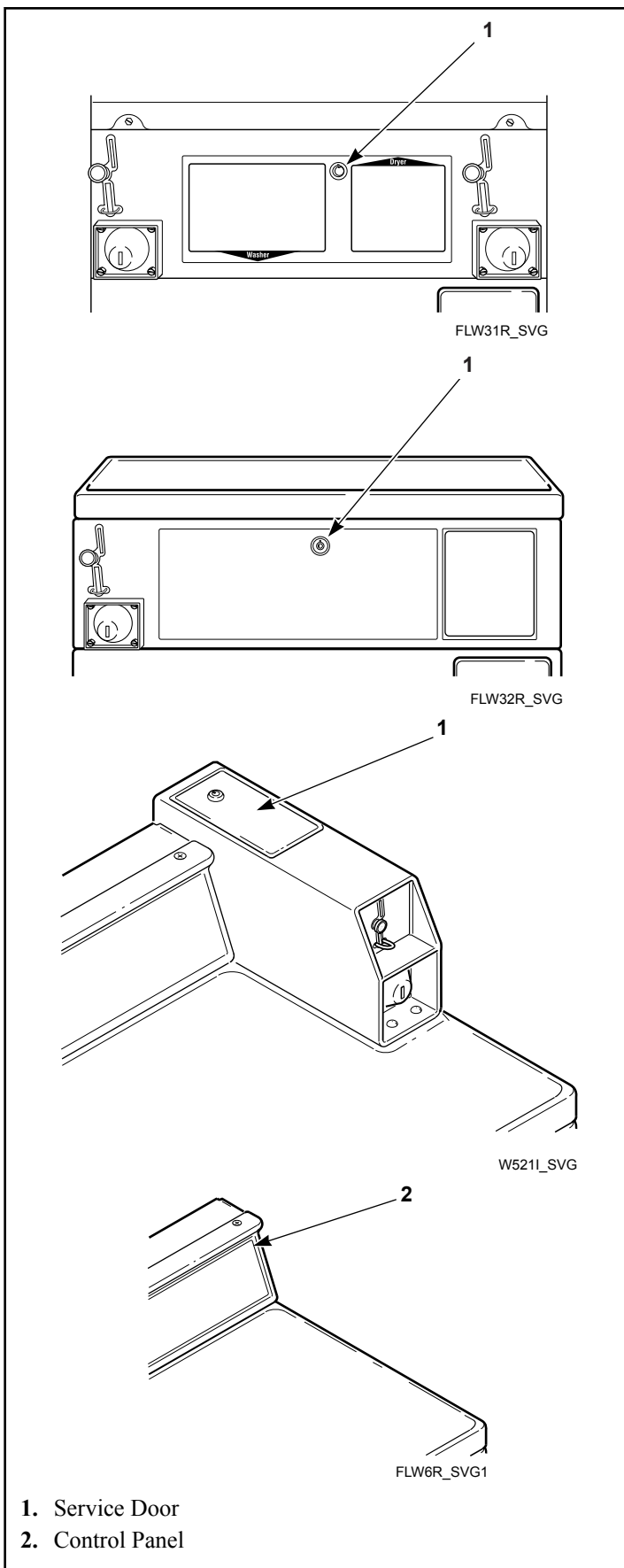

Figure 2

# Entering the Manual Mode

## How to Enter the Manual Mode

For programming, testing, and retrieving information from the control, it is often necessary to enter the Manual Mode by following the four simple steps below. For an overview of entering the Manual Mode, refer to the flowchart on the following page.

1. If accessing Diagnostic Tests that take control of machine operation, be sure the washer is in the Start or Ready Mode before continuing to step 2. If the washer is in an active cycle, rapid advance through the cycle. Refer to *Rapid Advance Feature*.
2. Stacked Washers and Dryers, 10 Degree Front Control Washers and Coin Rear Control Washers through Serial No. 181000001: Open the service door. The coin vault switch must be closed.
3. All Other Models: Open the service door, if necessary, and unplug bullet connector.
4. While pressing and holding the LIGHT keypad with one hand, press the NORMAL keypad with the other hand.
5. The display will show *rRP id*.
6. Press the DELICATES/BULKY ( $\wedge$ ) or the COLD ( $\vee$ ) keypad to scroll through the options until the desired option appears in the display.
7. Press the START (enter) keypad.

**NOTE: After entering Manual Mode, if no keypads are pressed for 4.25 minutes, the control will return to the previous mode of operation.**

8. To exit, press the WARM (<) keypad. The control will revert back to Ready Mode.

## Manual Mode Navigation

Manual Mode is broken into five groups: Manual Programming, Manual Read Audit, Manual Reset, Manual Rapid Advance and Manual Diagnostics.

Manual Programming can only be turned on or off with an external device or the network. Refer to the appropriate instruction manual. Manual Rapid Advance and Manual Diagnostics can be turned on and off using an external device, by manual programming, or with the network.

By default, all groups are turned on.

The manual features available in each group are as follows (the menu shown on the display in this mode is in parentheses).

- Manual Programming (*Prpg*)
- Manual Read Audit (*RAud it*)
- Manual Reset (*rESEt*)
- Rapid Advance (*rRP id*)
- Manual Diagnostic Tests (*d iAG*)

If a group is turned off, the display will change from the selected feature to *oFF* when the START (enter) pad is pressed. An audio signal will then sound for one (1) second and the display will return to the selected feature. The features in the group cannot be entered.

- Manual Mode: Enter by opening the service door for at least 1 second and then closing service door. Then press LIGHT and NORMAL keypads at the same time.
- Press the DELICATES/BULKY or COLD keypad to scroll through the Manual Mode options.
- Press the START keypad to enter any sub-menu options.

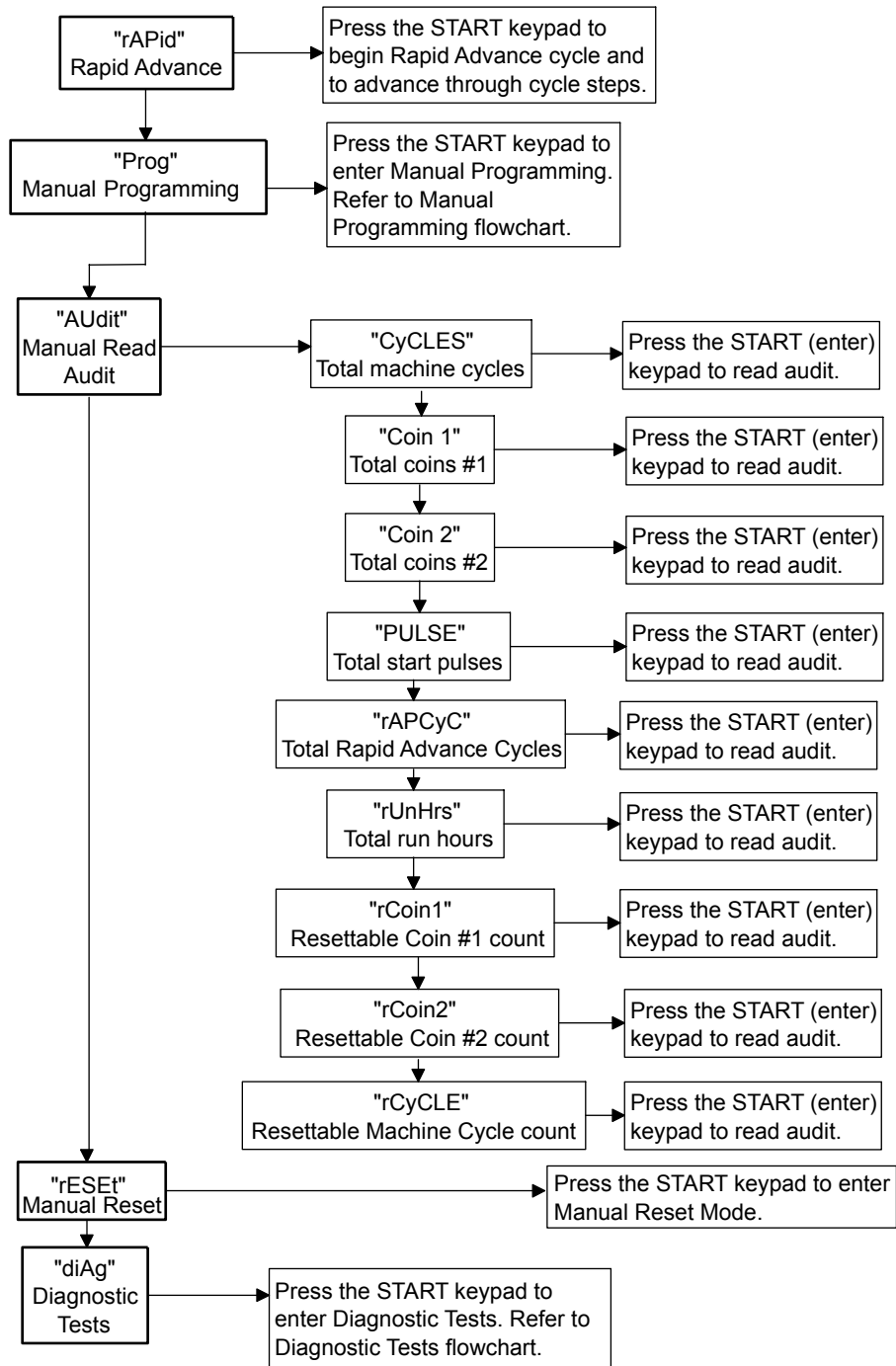

FLW103R\_SVG

Figure 4

# Programming Control

## What Can Be Programmed

This feature allows the owner to program cycle information, standard vend pricing, special vends and other features by using the keypads. The control must have the Manual Programming Mode enabled, which is the factory default.

This mode can only be turned “OFF” and “ON” by using an external device or the network.

Refer to this section when programming the control. This section offers a detailed description of all options available to program.

Each description includes instructions on when and why the option might be used and, more importantly, how to program the option.

For an overview of the programming organization, refer to the flowcharts on the following pages.

For more advanced users, a quick reference list of the options available through the programming mode is located on this page.

**NOTE: The letters and numbers in the Option Display column of the Programmable Options List are what will be shown in the display when that option is selected.**

## Programmable Options Available

Option Number	Option Display	Description	Factory Default	Value Range
1	<i>AL5 1</i>	Vend Price #1	200	0 - 65,535
2	<i>AL5 2</i>	Vend Price #2	200	0 - 65,535
3	<i>AL5 3</i>	Vend Price #3	200	0 - 65,535
4	<i>AL5 4</i>	Vend Price #4	200	0 - 65,535
5	<i>AL5 5</i>	Vend Price #5	200	0 - 65,535
6	<i>AL5 6</i>	Vend Price #6	200	0 - 65,535
7	<i>AL5 7</i>	Vend Price #7	200	0 - 65,535
8	<i>AL5 8</i>	Vend Price #8	200	0 - 65,535
9	<i>AL5 9</i>	Vend Price #9	200	0 - 65,535
10	<i>ALNP 1</i>	Cycle Modifier Key 1 Medium Vend Price Adder	25	0 - 65,535
11	<i>ALNP 2</i>	Cycle Modifier Key 2 Heavy Vend Price Add- er	50	0 - 65,535
12	<i>AL5 dP</i>	Vend Price Decimal Point	2	oFF, 2, 3
13	<i>dEn 1</i>	Coin #1 Value	25	1 - 65,535
14	<i>dEn 2</i>	Coin #2 Value	100	1 - 65,535
15	<i>PLSE</i>	Start Pulse Value	25	1 - 65,535

*Table continues...*



Option Number	Option Display	Description	Factory Default	Value Range
16	<i>PL5Mod</i>	Start Pulse Mode	128	0, 128, 192
17	<i>ALYPE</i>	Programmable Output Type	0	0 - 13
18	<i>dFLCYC</i>	Default Cycle	3	1 - 9
19	<i>CRrd</i>	Card Reader Display Control	oFF	on/oFF
20	<i>AUdio</i>	Audio Signal	29	0 - 31
21	<i>nodE</i>	Network Node Number	250	1 - 250
22	<i>Error-</i>	Errors Menu	—	—
a	<i>CErr-</i>	Coin Error Parameters Menu	—	—
1	<i>CErr 1</i>	Coin Error	on	on/oFF
2	<i>CErr 2</i>	Coin Error Penalty	oFF	on/oFF
3	<i>CErr 3</i>	Vend Header Present Error	on	on/oFF
b	<i>E FL-</i>	Fill Error Menu	—	—
1	<i>E FL 1</i>	Fill Error	on	on/oFF
2	<i>E FL 2</i>	Fill Error Time	30	2 - 59
c	<i>E nF-</i>	No Water Flow Error Menu	—	—
1	<i>E nF 1</i>	No Water Flow Error	on	on/oFF
2	<i>E nF 2</i>	No Water Flow Error Time	5	1 - 59
d	<i>E dr-</i>	Drain Error Menu	—	—
1	<i>E dr 1</i>	Drain Error	on	on/oFF
2	<i>E dr 2</i>	Drain Error Time	15 = Through Serial No. 1507032556 5 = Starting Serial No. 1507032557	1 - 59
e	<i>E Ld-</i>	Water Leak Detection Error Menu	—	—
1	<i>E Ld 1</i>	Water Leak Detection Day of Week	oFF	oFF, 3 - 255

Table continues...

Option Number	Option Display	Description	Factory Default	Value Range
2	<i>E Ld 2</i>	Water Leak Detection Number of Cycles	10	0 - 127
3	<i>E Ld 3</i>	Water Leak Detection Display Sequence	on	on/oFF
f	<i>E 5d-</i>	Slow Drain Detection Error Menu	—	—
1	<i>E 5d 1</i>	Slow Drain Detection	oFF	on/oFF
2	<i>E 5d 2</i>	Slow Drain Detection Adjust	0	0 - 255
g	<i>E Ub</i>	Non-Fatal Unbalance Error Display	oFF	on/oFF
h	<i>E 5L</i>	Suds Lock Error Display	oFF	on/oFF
i	<i>5Ud-</i>	Suds Removal Routine Menu	—	—
1	<i>5Ud 1</i>	Suds Removal Routine Display	oFF	on/oFF
2	<i>5Ud 2</i>	Suds Removal Routines Allowed Per Cycle	1	0 - 10
3	<i>5Ud 3</i>	Suds Removal Routine Extra Time	on	on/oFF
j	<i>ourFLd</i>	Overflow Mode Display	on	on/oFF
k	<i>ELrErr</i>	Allow Error Clearing	oFF	on/oFF
23	<i>FL Lo</i>	Low Water Level	6	1 - 30
24	<i>FL Med</i>	Medium Water Level	10	1 - 30
25	<i>FL Hi</i>	High Water Level	15	1 - 30
26	<i>FLSH t</i>	Flush Out Time for Fill Steps	25	0 - 255
27	<i>norF t</i>	No Refill After Time for Agitate Steps	255	0 - 255
28	<i>rEtC-</i>	Real Time Clock Menu	—	—
a	<i>rEtC 1</i>	Set Real Time Clock Minutes	—	0 - 59

Table continues...

Option Number	Option Display	Description	Factory Default	Value Range
b	rEL 2	Set Real Time Clock Hours	—	0 - 23
c	rEL 3	Set Real Time Clock Day of Week	—	1 - 7
d	rEL 4	Set Real Time Clock Date of Month	—	1 - 31
e	rEL 5	Set Real Time Clock Month	—	1 - 12
f	rEL 6	Set Real Time Clock Year	—	0 - 99
29	dL5-	Daylight Savings Option Menu	—	—
a	dL5 1	Daylight Saving	on	on/oFF
b	dL5 2	Start Month	—	1 - 12
c	dL5 3	Start Day of Week	—	1 - 7
d	dL5 4	Start Week of Month	—	1 - 4
e	dL5 5	Start Hour	—	0 - 23
f	dL5 6	End Month	—	1 - 12
g	dL5 7	End Day of Week	—	1 - 7
h	dL5 8	End Week of Month	—	1 - 4
i	dL5 9	End Hour	—	0 - 23
30	SP 1-	Special Vend 1 Parameters Menu	—	—
a	SP 1 1	Special Vend 1 Days of Week Enable	oFF	Refer to <i>Table 8</i>
b	SP 1 2	Special Vend 1 Start Minute	0	0 - 59
c	SP 1 3	Special Vend 1 Start Hour	0	0 - 23
d	SP 1 4	Special Vend 1 Start Date	oFF	oFF, 1 - 31
e	SP 1 5	Special Vend 1 Start Month	oFF	oFF, 1 - 12

*Table continues...*

Option Number	Option Display	Description	Factory Default	Value Range
f	<i>SP 1 6</i>	Special Vend 1 Start Year	0	0 - 99
g	<i>SP 1 7</i>	Special Vend 1 Length in Hours	0	0 - 24
h	<i>SP 1 8</i>	Special Vend 1 End Date	oFF	oFF, 1 - 31
i	<i>SP 1 9</i>	Special Vend 1 End Month	oFF	oFF, 1 - 12
j	<i>SP 1 10</i>	Special Vend 1 End Year	0	0 - 99
k	<i>SP 1 11</i>	Special Vend 1 Price #1	0	0 - 65,535
l	<i>SP 1 12</i>	Special Vend 1 Price #2	0	0 - 65,535
m	<i>SP 1 13</i>	Special Vend 1 Price #3	0	0 - 65,535
n	<i>SP 1 14</i>	Special Vend 1 Price #4	0	0 - 65,535
o	<i>SP 1 15</i>	Special Vend 1 Price #5	0	0 - 65,535
p	<i>SP 1 16</i>	Special Vend 1 Price #6	0	0 - 65,535
q	<i>SP 1 17</i>	Special Vend 1 Price #7	0	0 - 65,535
r	<i>SP 1 18</i>	Special Vend 1 Price #8	0	0 - 65,535
s	<i>SP 1 19</i>	Special Vend 1 Price #9	0	0 - 65,535
t	<i>SP 1 20</i>	Special Vend 1 Wash Status Agitate Steps Added Minutes	0	0 - 10
u	<i>SP 1 21</i>	Special Vend 1 Wash Status Agitate Steps Subtracted Minutes	0	0 - 10
v	<i>SP 1 22</i>	Special Vend 1 Cycle Modifier Default Value	0	0 - 2

*Table continues...*

Option Number	Option Display	Description	Factory Default	Value Range
w	<i>SP 1 23</i>	Special Vend 1 Cycle Modifier Key #1 Medium Vend Price	0	0 - 65,535
x	<i>SP 1 24</i>	Special Vend 1 Cycle Modifier Key #2 Heavy Vend Price	0	0 - 65,535
y	<i>SP 1 25</i>	Special Vend 1 Cycle Modifier Key #1 Medium Options	0	0 - 31
z	<i>SP 1 26</i>	Special Vend 1 Cycle Modifier Key #2 Heavy Options	0	0 - 31
aa	<i>SP 1 27</i>	Special Vend 1 Extract Speed Limit	<i>ULTRA HIGH</i>	Very Low, Low, Medium, High, Very High, Ultra High, (37.40 - 439.70 G Force; 350 - 1200 RPM)
31	<i>SP2</i>	Special Vend 2 Enable	oFF	on/oFF
32	<i>SP3</i>	Special Vend 3 Enable	oFF	on/oFF
33	<i>SP4</i>	Special Vend 4 Enable	oFF	on/oFF
34	<i>CNP-</i>	Cycle Modifier Programming Menu	—	—
a	<i>CNP 1</i>	Default Cycle Modifier	0	0 - 2
b	<i>CNP 2</i>	Cycle Modifier Key #1 Medium Options	2 = Through Serial No. 1503031610 1 = Starting Serial No. 1503031611	0 - 31
c	<i>CNP 3</i>	Cycle Modifier Key #2 Heavy Options	3	0 - 31
d	<i>CNP 4</i>	Cycle Modifier Medium Additional Wash Time	2	0 - 15
e	<i>CNP 5</i>	Cycle Modifier Medium Additional Rinse Time	2	0 - 15
f	<i>CNP 6</i>	Cycle Modifier Heavy Additional Wash Time	4	0 - 15

Table continues...

Option Number	Option Display	Description	Factory Default	Value Range
g	<i>CNP 7</i>	Cycle Modifier Heavy Additional Rinse Time	4	0 - 15
35	<i>CYCLE-</i>	Cycle Programming Menu	—	—
a	<i>CYCLE1</i>	Cycle 1	—	—
b	<i>CYCLE2</i>	Cycle 2	—	—
c	<i>CYCLE3</i>	Cycle 3	—	—
d	<i>CYCLE4</i>	Cycle 4	—	—
e	<i>CYCLE5</i>	Cycle 5	—	—
f	<i>CYCLE6</i>	Cycle 6	—	—
g	<i>CYCLE7</i>	Cycle 7	—	—
h	<i>CYCLE8</i>	Cycle 8	—	—
i	<i>CYCLE9</i>	Cycle 9	—	—
36	<i>CNESS-</i>	Hold Step Custom Messages Menu	—	—
a	<i>CNESS1</i>	Custom Message #1	CUSStM1	—
b	<i>CNESS2</i>	Custom Message #2	CUSStM2	—
37	<i>PCYCLtd</i>	Programmable Cycle Time Display Enable	oFF	on/oFF
38	<i>nCYCLtd</i>	No Cycle Time Display	oFF	on/oFF
39	<i>bAL At</i>	Number of Balance Attempts with No Loss of Time	Through Serial No. 1506011826 = 4 Starting Serial No. 1506011827 = 7	1 - 7
40	<i>CYCPAU</i>	Cycle Pause Resume	oFF	on/oFF
41	<i>LPAS 1</i>	Low Power/Auto Shut-down 1 Days Enable	oFF	on/oFF
42	<i>LPAS 2</i>	Low Power/Auto Shut-down 2 Days Enable	oFF	on/oFF
43	<i>LPAS 3</i>	Low Power/Auto Shut-down 3 Days Enable	oFF	on/oFF
44	<i>LPAS 4</i>	Low Power/Auto Shut-down 4 Days Enable	oFF	on/oFF

*Table continues...*

Option Number	Option Display	Description	Factory Default	Value Range
45	<i>PF rSt</i>	Power Fail Reset	oFF	oFF, 0 - 120
46	<i>irA En</i>	IR Access	on	on/oFF
47	<i>rRPdEn</i>	Manual Rapid Advance Access	on	on/oFF
48	<i>d iR9En</i>	Manual Diagnostics Access	on	on/oFF
49	<i>Ft En</i>	Factory Test Access	on	on/oFF
50	<i>LUC -</i>	Lucky Cycle Menu	—	—
a	<i>LUC 1</i>	Lucky Cycle Day(s) of Week / Enable On/Off	oFF	oFF, 3 - 255
b	<i>LUC 2</i>	Lucky Cycle Number	50	1 - 255
c	<i>LUC 3</i>	Lucky Cycle Display Option	oFF	on/oFF
51	<i>tP ind</i>	Temperature Indicator Display	oFF	on/oFF
52	<i>SUn iE5</i>	Speed Units	RPM	RPM/G Force
53	<i>PCdL</i>	Programmable Close Door Display	on	on/oFF
54	<i>PPSt</i>	Programmable Push Start Display	on	on/oFF
55	<i>PodL</i>	Programmable Open Door Display	on	on/oFF
56	<i>Rt5 do</i>	Vend Price Display Override	oFF	on/oFF
57	<i>oPL -</i>	OPL Parameters	—	—
a	<i>oPL 1</i>	OPL Mode Enable	oFF	on/oFF
b	<i>oPL 2</i>	OPL Delayed Start	oFF	on/oFF
c	<i>oPL 3</i>	OPL Display Power Save	on	on/oFF
58	<i>droP</i>	Drop Off Mode	oFF	on/oFF
59	<i>oUt</i>	Out of Order	oFF	on/oFF

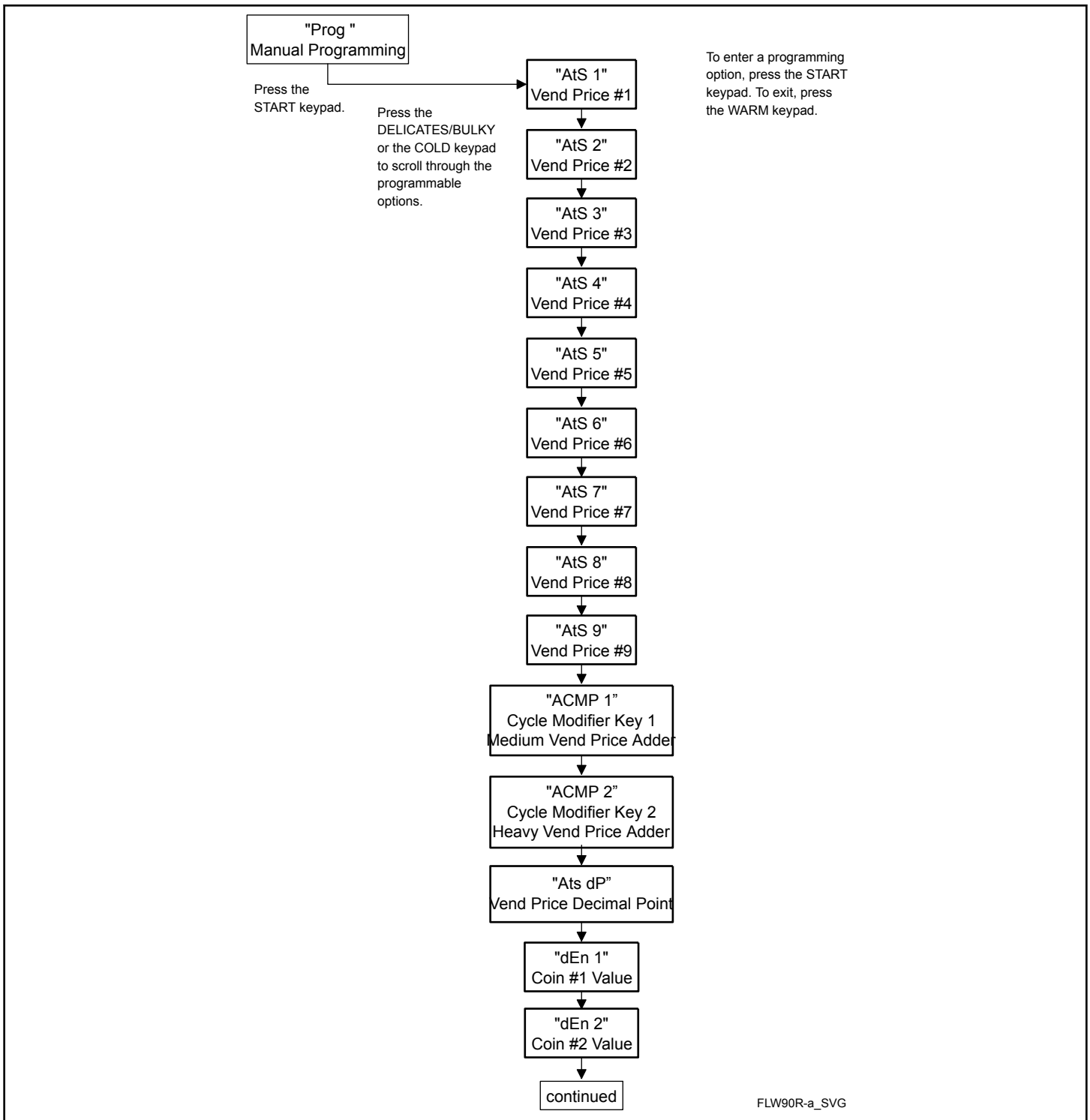

Figure 5



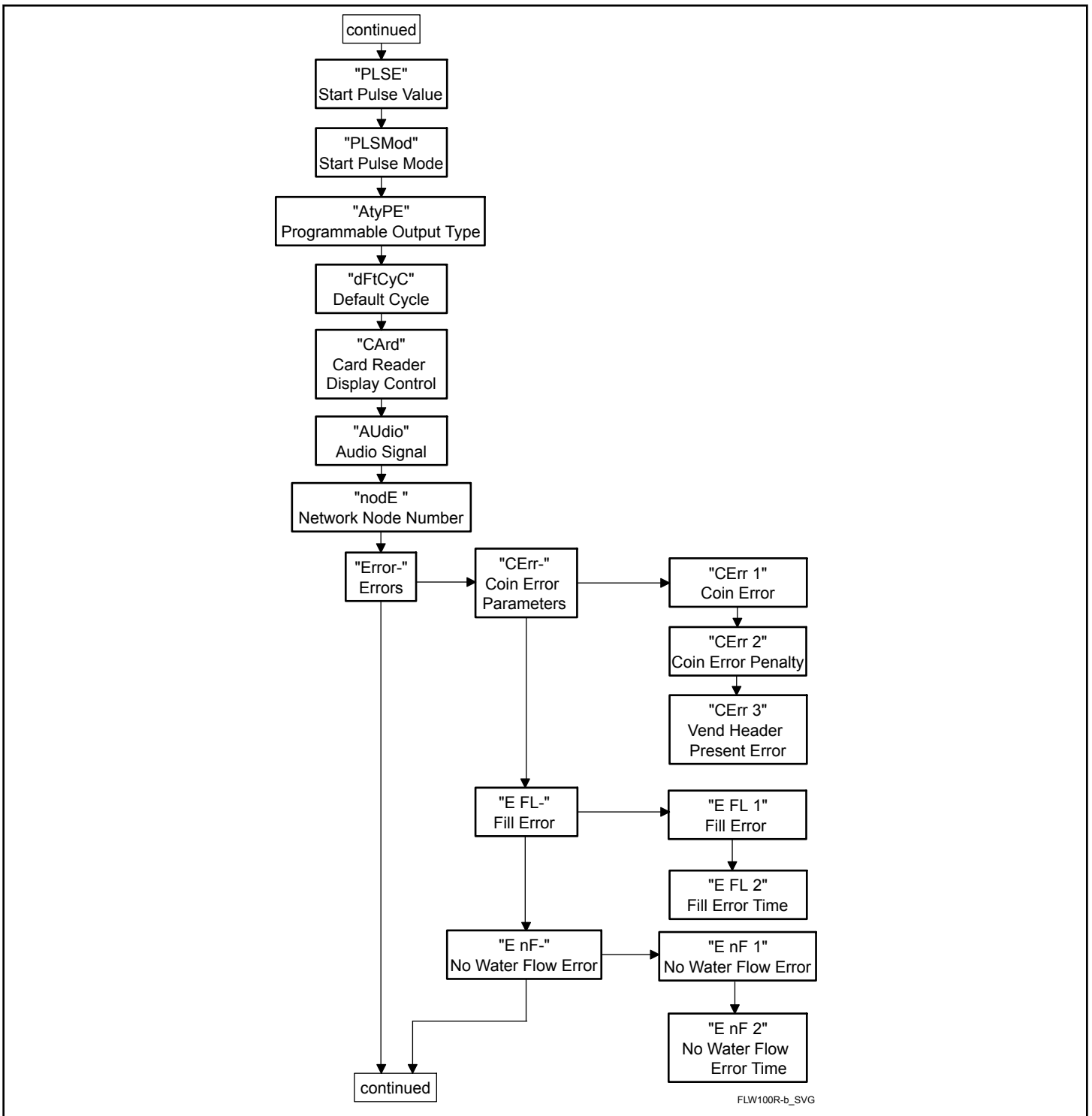
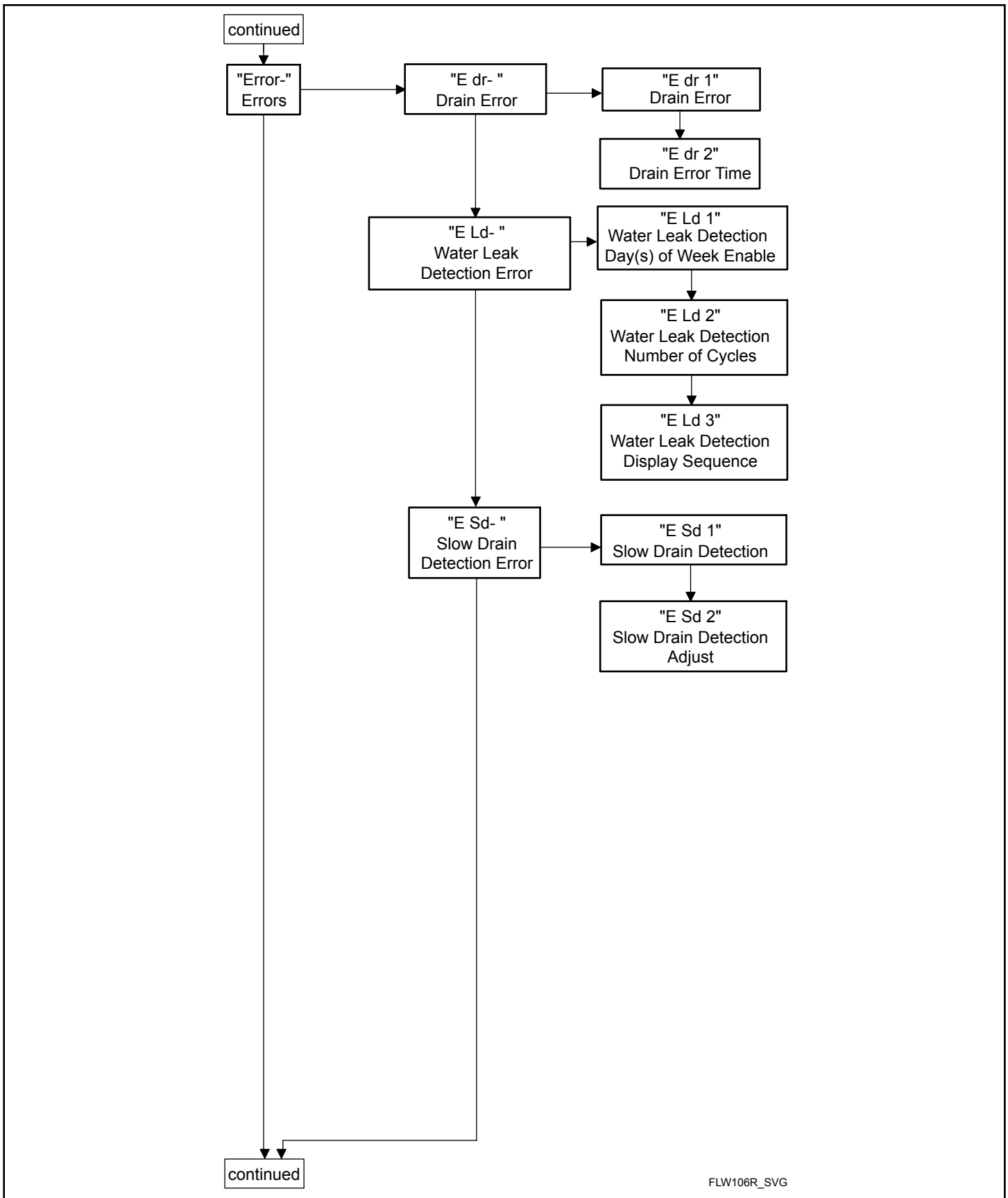
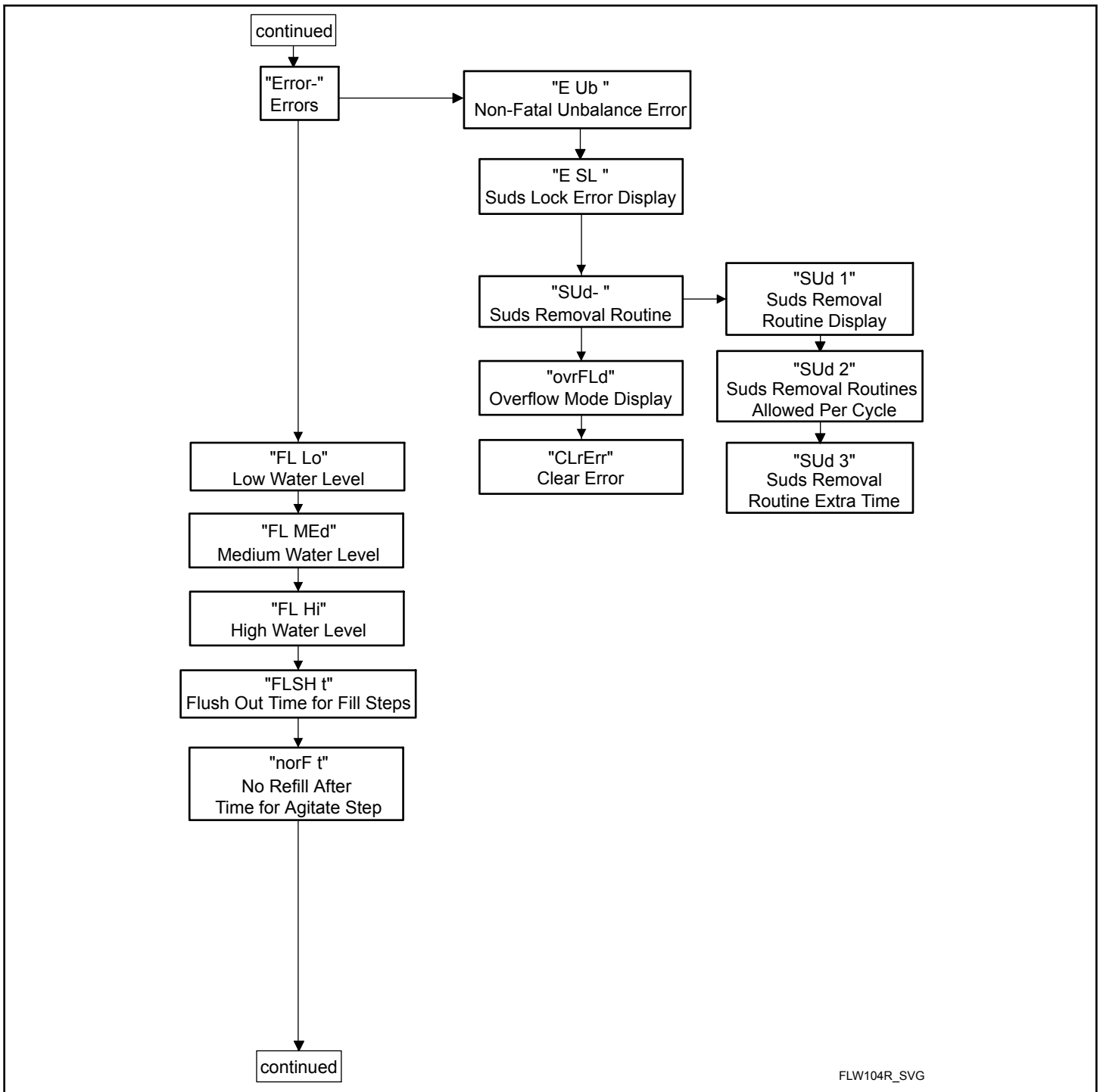

Figure 6



FLW106R\_SVG

Figure 7



FLW104R\_SVG

Figure 8

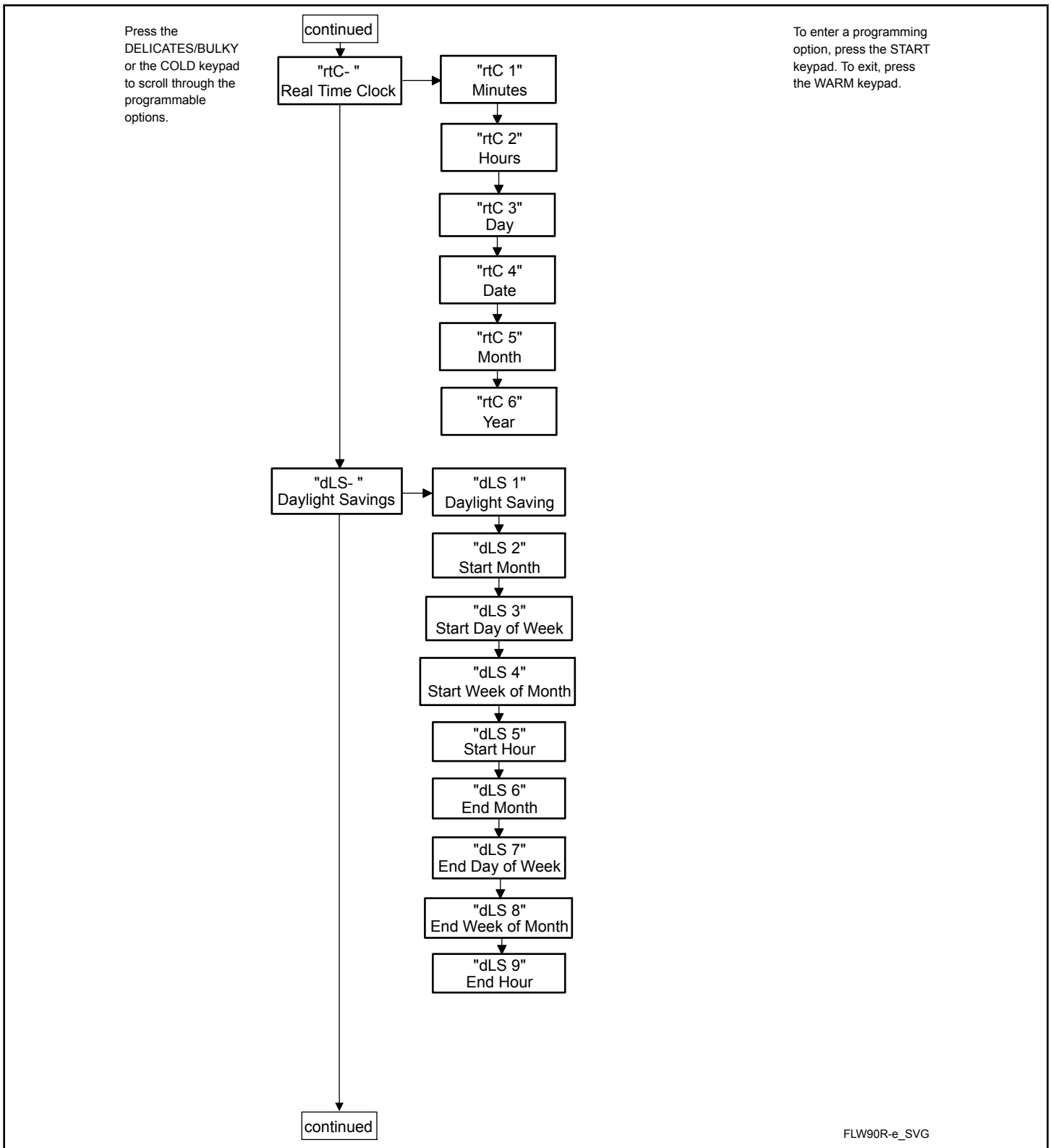

Figure 9

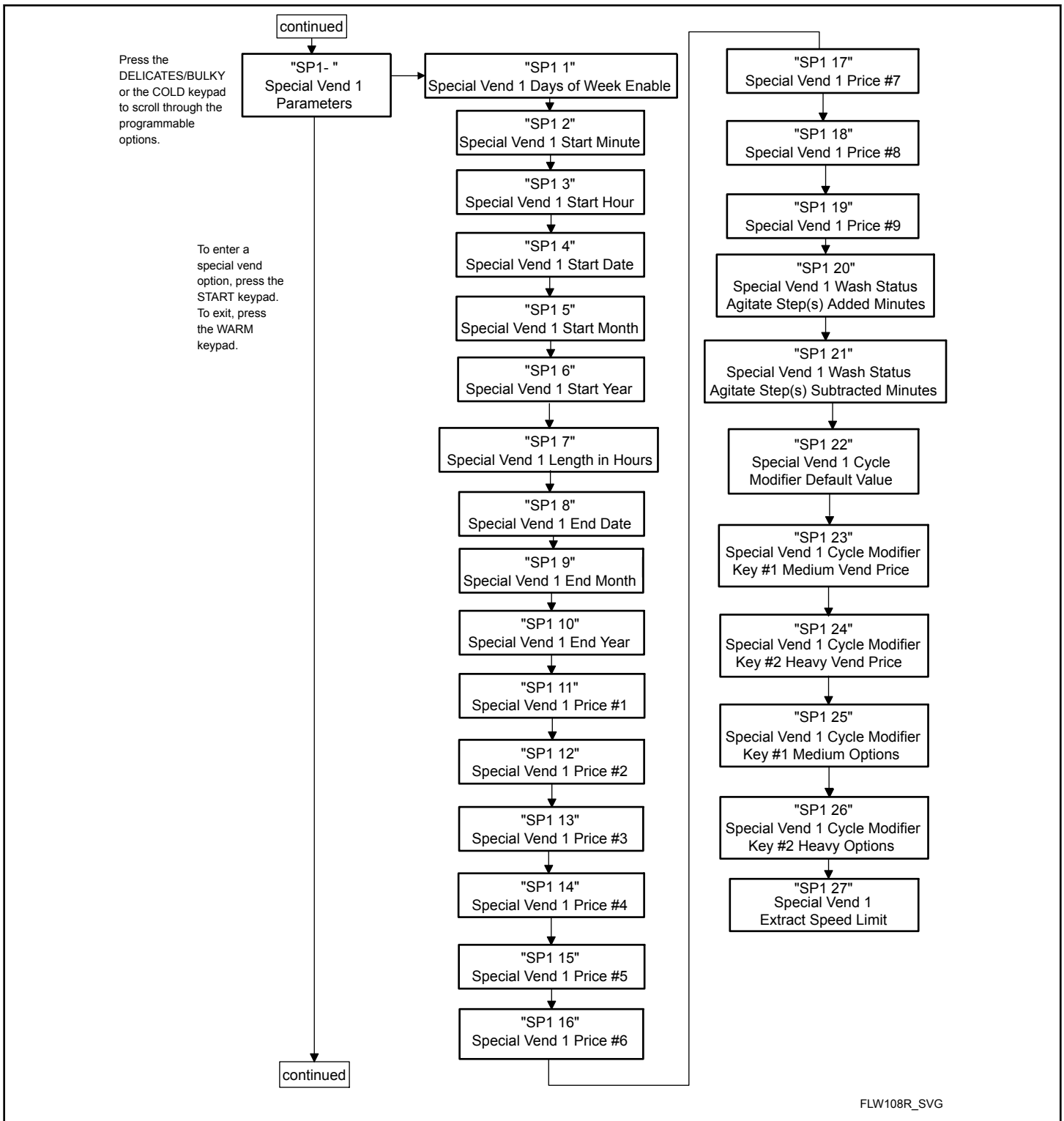

Figure 10

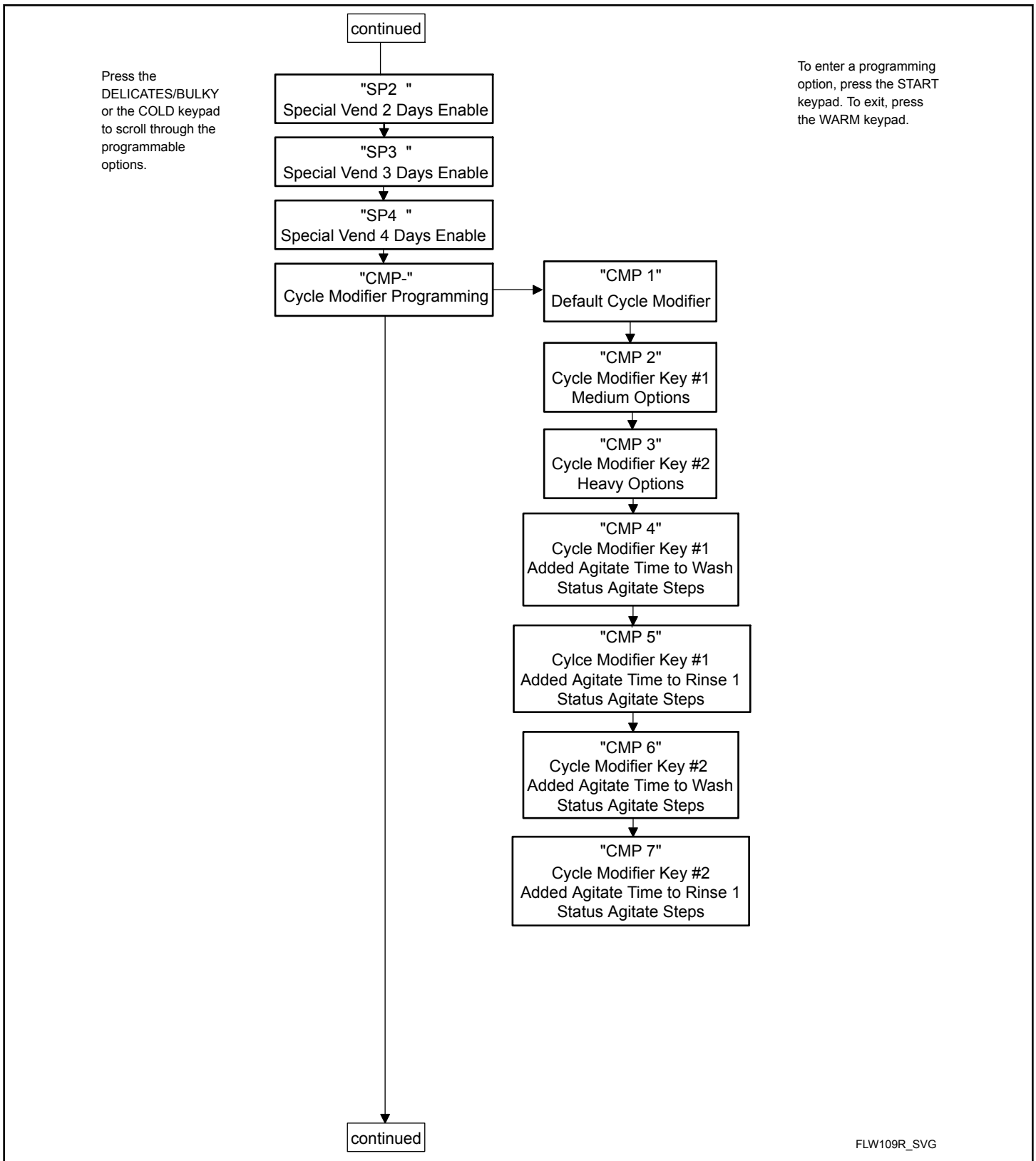

Figure 11

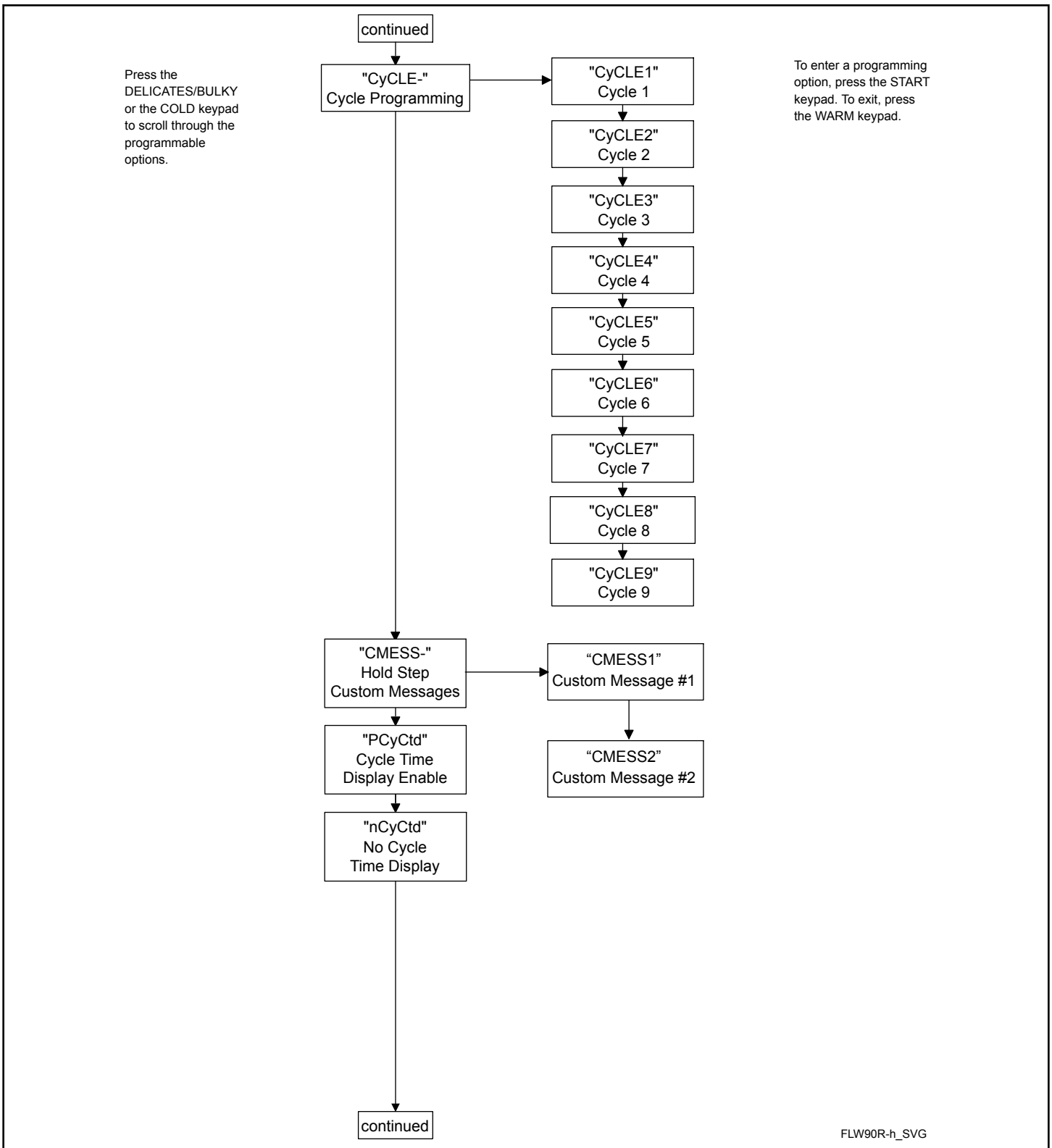
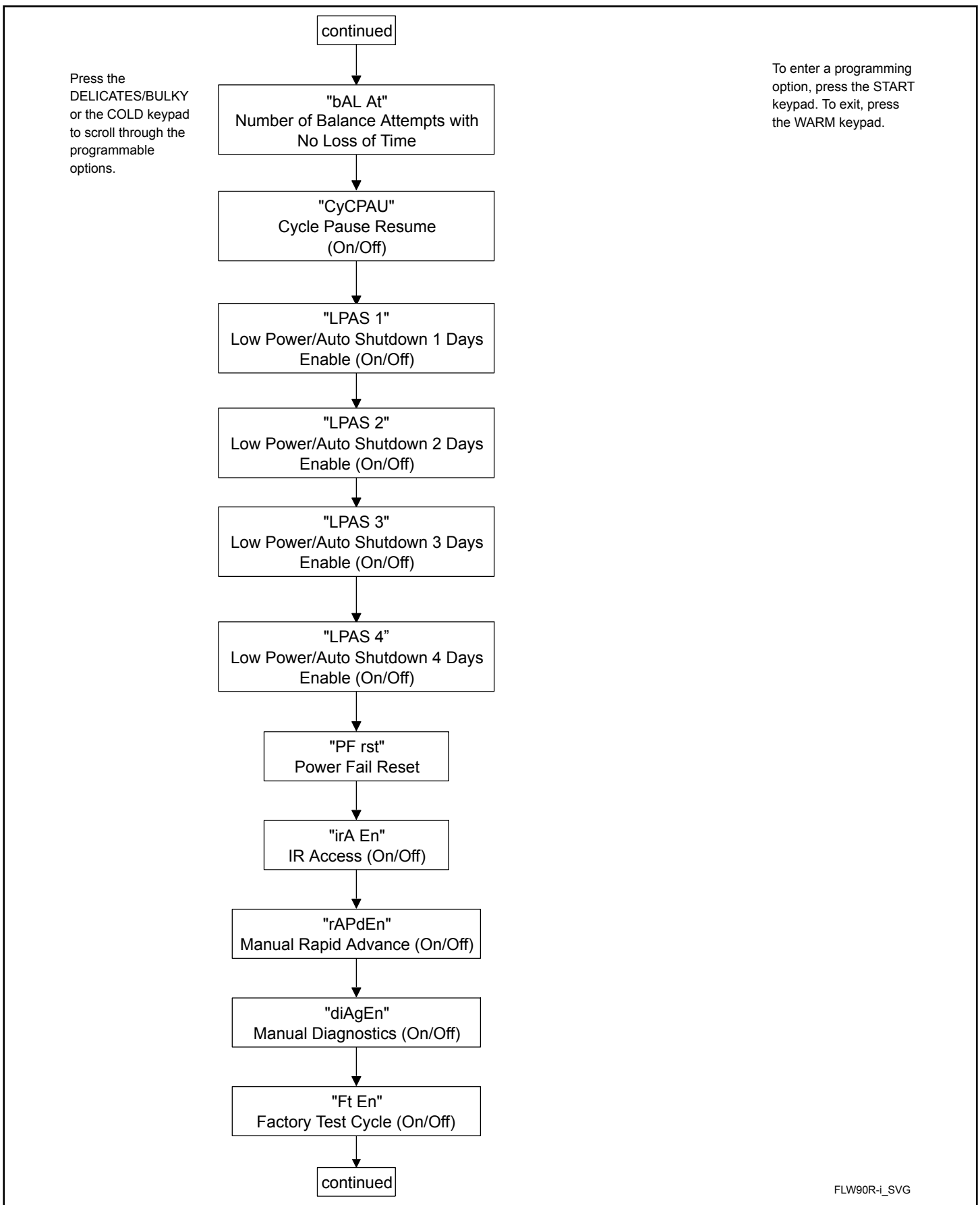

Figure 12

FLW90R-h\_SVG



FLW90R-i\_SVG

Figure 13



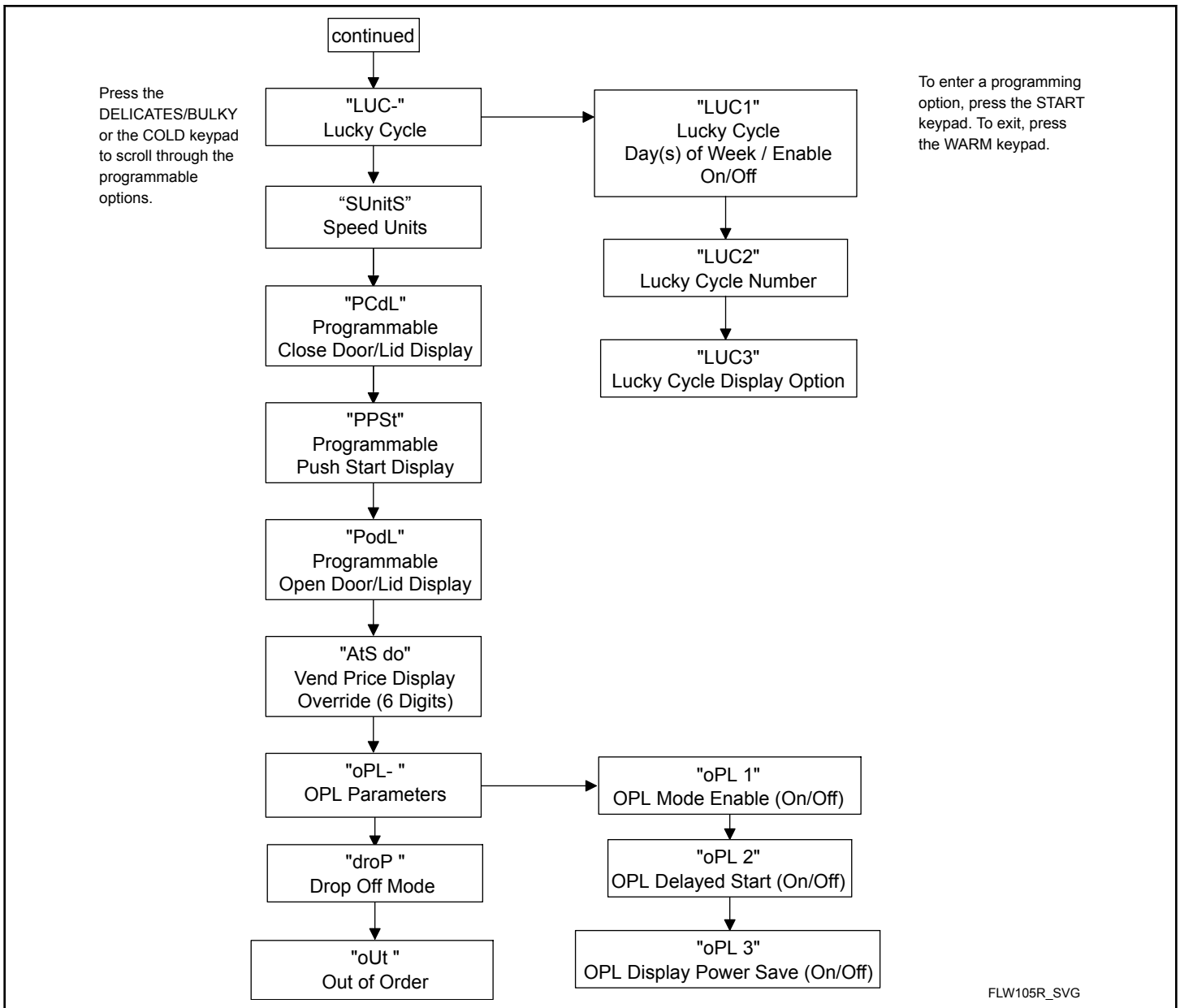

Figure 14

## Vend Price 1 *AtS I*

This option allows the owner to set the vend price for all cycles, but otherwise specifically for NORMAL HOT. This price should be set before all other prices. This vend price will be shown in the display when NORMAL HOT is selected.

1. Control must be in Manual Mode. Refer to *How to Enter the Manual Mode*.
2. Press the DELICATES/BULKY ( $\Delta$ ) or the COLD ( $\nabla$ ) keypad until *Pr-o9* appears in the display. Press the START (enter) keypad, and *AtS I* will appear in the display.
3. Press the START (enter) keypad. All cycle LEDs will be lit to show all cycle prices are being programmed.

**NOTE: To go back to the current programmable option without changing the value, press the WARM (<) keypad.**

4. Press the DELICATES/BULKY ( $\Delta$ ) or the COLD ( $\nabla$ ) keypad to increase or decrease the value of the active digit and the START (enter) keypad to enter the value of the digit and advance to the next digit.
5. Press the START (enter) keypad when the correct value appears in the display. The new value is saved and the next option will appear in the display.

## Vend Price 2 *RLS 2*

This option allows the owner to set the vend price for NORMAL WARM. This vend price will be shown in the display when NORMAL WARM is selected.

1. Control must be in Manual Mode. Refer to *How to Enter the Manual Mode*.
2. Press the DELICATES/BULKY ( $\wedge$ ) or the COLD ( $\vee$ ) keypad until *Prpg* appears in the display. Press the START (enter) keypad, and *RLS 1* will appear in the display.
3. The keypad LEDs will be lit to show which cycle price is being programmed.
4. When *RLS 2* appears in the display, press the START (enter) keypad.

**NOTE: To go back to the current programmable option without changing the value, press the WARM ( $\leftarrow$ ) keypad.**

5. Press the DELICATES/BULKY ( $\wedge$ ) or the COLD ( $\vee$ ) keypad to increase or decrease the value of the active digit and the START (enter) keypad to enter the value of the digit and advance to the next digit.
6. Press the START (enter) keypad when the correct value appears in the display. The new value is saved and the next option will appear in the display.

## Vend Price 3 *RLS 3*

This option allows the owner to set the vend price for a NORMAL COLD. This vend price will be shown in the display when NORMAL COLD is selected.

1. Control must be in Manual Mode. Refer to *How to Enter the Manual Mode*.
2. Press the DELICATES/BULKY ( $\wedge$ ) or the COLD ( $\vee$ ) keypad until *Prpg* appears in the display. Press the START (enter) keypad, and *RLS 1* will appear in the display.
3. The keypad LEDs will be lit to show which cycle price is being programmed.
4. When *RLS 3* appears in the display, press the START (enter) keypad.

**NOTE: To go back to the current programmable option without changing the value, press the WARM ( $\leftarrow$ ) keypad.**

5. Press the DELICATES/BULKY ( $\wedge$ ) or the COLD ( $\vee$ ) keypad to increase or decrease the value of the active digit and the START (enter) keypad to enter the value of the digit and advance to the next digit.
6. Press the START (enter) keypad when the correct value appears in the display. The new value is saved and the next option will appear in the display.

## Vend Price 4 *RLS 4*

This option allows the owner to set the vend price for a PERM PRESS HOT. This vend price will be shown in the display when PERM PRESS HOT is selected.

1. Control must be in Manual Mode. Refer to *How to Enter the Manual Mode*.
2. Press the DELICATES/BULKY ( $\wedge$ ) or the COLD ( $\vee$ ) keypad until *Prpg* appears in the display. Press the START (enter) keypad, and *RLS 1* will appear in the display.
3. Press the DELICATES/BULKY ( $\wedge$ ) or the COLD ( $\vee$ ) keypad to scroll through the programmable options until *RLS 4* appears in the display.
4. The keypad LEDs will be lit to show which cycle price is being programmed.

5. When *RLS 4* appears in the display, press the START (enter) keypad.

**NOTE: To go back to the current programmable option without changing the value, press the WARM ( $\leftarrow$ ) keypad.**

6. Press the DELICATES/BULKY ( $\wedge$ ) or the COLD ( $\vee$ ) keypad to increase or decrease the value of the active digit and the START (enter) keypad to enter the value of the digit and advance to the next digit.
7. Press the START (enter) keypad when the correct value appears in the display. The new value is saved and the next option will appear in the display.

## Vend Price 5 *RLS 5*

This option allows the owner to set the vend price for PERM PRESS WARM. This vend price will be shown in the display when PERM PRESS WARM is selected.

1. Control must be in Manual Mode. Refer to *How to Enter the Manual Mode*.
2. Press the DELICATES/BULKY ( $\wedge$ ) or the COLD ( $\vee$ ) keypad until *Prpg* appears in the display. Press the START (enter) keypad, and *RLS 1* will appear in the display.
3. Press the DELICATES/BULKY ( $\wedge$ ) or the COLD ( $\vee$ ) keypad to scroll through the programmable options until *RLS 5* appears in the display.
4. The keypad LEDs will be lit to show which cycle price is being programmed.

5. When *RLS 5* appears in the display, press the START (enter) keypad.

**NOTE: To go back to the current programmable option without changing the value, press the WARM ( $\leftarrow$ ) keypad.**

6. Press the DELICATES/BULKY ( $\wedge$ ) or the COLD ( $\vee$ ) keypad to increase or decrease the value of the active digit and the START (enter) keypad to enter the value of the digit and advance to the next digit.

7. Press the START (enter) keypad when the correct value appears in the display. The new value is saved and the next option will appear in the display.

## Vend Price 6 *RL5 6*

This option allows the owner to set the vend price for PERM PRESS COLD. This vend price will be shown in the display when PERM PRESS COLD is selected.

1. Control must be in Manual Mode. Refer to *How to Enter the Manual Mode*.
2. Press the DELICATES/BULKY ( $\wedge$ ) or the COLD (v) keypad until *Pr-09* appears in the display. Press the START (enter) keypad, and *RL5 1* will appear in the display.
3. Press the DELICATES/BULKY ( $\wedge$ ) or the COLD (v) keypad to scroll through the programmable options until *RL5 6* appears in the display.
4. The keypad LEDs will be lit to show which cycle price is being programmed.
5. When *RL5 6* appears in the display, press the START (enter) keypad.  
**NOTE: To go back to the current programmable option without changing the value, press the WARM (<) keypad.**
6. Press the DELICATES/BULKY ( $\wedge$ ) or the COLD (v) keypad to increase or decrease the value of the active digit and the START (enter) keypad to enter the value of the digit and advance to the next digit.
7. Press the START (enter) keypad when the correct value appears in the display. The new value is saved and the next option will appear in the display.

## Vend Price 7 *RL5 7*

This option allows the owner to set the vend price for DELICATES/BULKY HOT. This vend price will be shown in the display when DELICATES/BULKY HOT is selected.

1. Control must be in Manual Mode. Refer to *How to Enter the Manual Mode*.
2. Press the DELICATES/BULKY ( $\wedge$ ) or the COLD (v) keypad until *Pr-09* appears in the display. Press the START (enter) keypad, and *RL5 1* will appear in the display.
3. Press the DELICATES/BULKY ( $\wedge$ ) or the COLD (v) keypad to scroll through the programmable options until *RL5 7* appears in the display.
4. The DELICATES/BULKY and HOT LEDs will be lit to show which cycle/temperature price is being programmed.
5. When *RL5 7* appears in the display, press the START (enter) keypad.  
**NOTE: To go back to the current programmable option without changing the value, press the WARM (<) keypad.**

6. Press the DELICATES/BULKY ( $\wedge$ ) or the COLD (v) keypad to increase or decrease the value of the active digit and the START (enter) keypad to enter the value of the digit and advance to the next digit.
7. Press the START (enter) keypad with the last active digit. The next option, *RL5 8*, will appear in the display.

## Vend Price 8 *RL5 8*

This option allows the owner to set the vend price for DELICATES/BULKY WARM. This vend price will be shown in the display when DELICATES/BULKY WARM is selected.

1. Control must be in Manual Mode. Refer to *How to Enter the Manual Mode*.
2. Press the DELICATES/BULKY ( $\wedge$ ) or the COLD (v) keypad until *Pr-09* appears in the display. Press the START (enter) keypad, and *RL5 1* will appear in the display.
3. Press the DELICATES/BULKY ( $\wedge$ ) or the COLD (v) keypad to scroll through the programmable options until *RL5 8* appears in the display.
4. The DELICATES/BULKY and WARM LEDs will be lit to show which cycle/temperature price is being programmed.
5. When *RL5 8* appears in the display, press the START (enter) keypad.  
**NOTE: To go back to the current programmable option without changing the value, press the WARM (<) keypad.**
6. Press the DELICATES/BULKY ( $\wedge$ ) or the COLD (v) keypad to increase or decrease the value of the active digit and the START (enter) keypad to enter the value of the digit and advance to the next digit.
7. Press the START (enter) keypad with the last active digit. The next option, *RL5 9*, will appear in the display.

## Vend Price 9 *RL5 9*

This option allows the owner to set the vend price for DELICATES/BULKY COLD. This vend price will be shown in the display when DELICATES/BULKY COLD is selected.

1. Control must be in Manual Mode. Refer to *How to Enter the Manual Mode*.
2. Press the DELICATES/BULKY ( $\wedge$ ) or the COLD (v) keypad until *Pr-09* appears in the display. Press the START (enter) keypad, and *RL5 1* will appear in the display.
3. Press the DELICATES/BULKY ( $\wedge$ ) or the COLD (v) keypad to scroll through the programmable options until *RL5 9* appears in the display.
4. The DELICATES/BULKY and COLD LEDs will be lit to show which cycle/temperature price is being programmed.
5. When *RL5 9* appears in the display, press the START (enter) keypad.

**NOTE: To go back to the current programmable option without changing the value, press the WARM (<) keypad.**

6. Press the DELICATES/BULKY (Λ) or the COLD (V) keypad to increase or decrease the value of the active digit and the START (enter) keypad to enter the value of the digit and advance to the next digit.
7. Press the START (enter) keypad with the last active digit. The next option, *dEn 1*, will appear in the display.

## Cycle Modifier Key 1 MEDIUM Vend Price Adder *ACNP 1*

This option allows the owner to set the vend price for the MEDIUM modifier key. This price is added onto the cycle price.

1. Control must be in Manual Mode. Refer to *How to Enter the Manual Mode*.
2. Press the DELICATES/BULKY (Λ) or the COLD (V) keypad until *Pr o 9* appears in the display. Press the START (enter) keypad, and *Ac 5 1* will appear in the display.
3. Press the DELICATES/BULKY (Λ) or the DELICATES COLD (V) keypad to scroll through the programmable options until *ACNP 1* appears in the display.
4. The MEDIUM modifier LED will be lit to show which price is being programmed.

5. When *ACNP 1* appears in the display, press the START (enter) keypad.

**NOTE: To go back to the current programmable option without changing the value, press the WARM (<) keypad.**

6. Press the DELICATES/BULKY (Λ) or the COLD (V) keypad to increase or decrease the value of the active digit and the START (enter) keypad to enter the value of the digit and advance to the next digit.
7. Press the START (enter) keypad when the correct value appears in the display. The new value is saved and the next option will appear in the display.

## Cycle Modifier Key 2 HEAVY Vend Price Adder *ACNP 2*

This option allows the owner to set the vend price for the HEAVY modifier key. This price is added onto the cycle price.

1. Control must be in Manual Mode. Refer to *How to Enter the Manual Mode*.
2. Press the DELICATES/BULKY (Λ) or the COLD (V) keypad until *Pr o 9* appears in the display. Press the START (enter) keypad, and *Ac 5 1* will appear in the display.
3. Press the DELICATES/BULKY (Λ) or the COLD (V) keypad to scroll through the programmable options until *ACNP 2* appears in the display.

4. The HEAVY modifier LED will be lit to show which price is being programmed.
5. When *ACNP 2* appears in the display, press the START (enter) keypad.

**NOTE: To go back to the current programmable option without changing the value, press the WARM (<) keypad.**

6. Press the DELICATES/BULKY (Λ) or the COLD (V) keypad to increase or decrease the value of the active digit and the START (enter) keypad to enter the value of the digit and advance to the next digit.
7. Press the START (enter) keypad when the correct value appears in the display. The new value is saved and the next option will appear in the display.

## Vend Price Decimal Point *Ac 5 dP*

This option allows the owner to enable a decimal point to show up in the vend price at one of two locations. For example, a vend price of *200* can be display with a decimal point as *200* or *0200*.

1. Control must be in Manual Mode. Refer to *How to Enter the Manual Mode*.
2. Press the DELICATES/BULKY (Λ) or the COLD (V) keypad until *Pr o 9* appears in the display. Press the START (enter) keypad, and *Ac 5 1* will appear in the display.
3. Press the DELICATES/BULKY (Λ) or the COLD (V) keypad to scroll through the programmable options until *Ac 5 dP* appears in the display.
4. When *Ac 5 dP* appears in the display, press the START (enter) keypad.

**NOTE: To go back to the current programmable option without changing the value, press the WARM (<) keypad.**

5. Press the DELICATES/BULKY (Λ) or the COLD (V) keypad to increase or decrease the value of the parameter.
6. Press the START (enter) keypad when the correct value appears in the display. The new value is saved and the next option will appear in the display.

## Coin 1 Value *dEn 1*

This option allows the owner to set a specific numerical value for a coin entered. For example, in the United States the coin value for one quarter would be measured in cents (25). Therefore, the coin value entered for one quarter would be 00025.

If the Vend Price 1 is set for “.75”, and the Coin Value is set for “00025”, the vend price displayed will decrease by 0.25 for each coin entered and 3 coins will need to be entered to satisfy the vend price.

1. Control must be in Manual Mode. Refer to *How to Enter the Manual Mode*.

2. Press the DELICATES/BULKY ( $\wedge$ ) or the COLD (v) keypad until **Pr09** appears in the display. Press the START (enter) keypad, and **Rt5 1** will appear in the display.
3. Press the DELICATES/BULKY ( $\wedge$ ) or the COLD (v) keypad to scroll through the programmable options until **dEn 1** appears in the display.
4. When **dEn 1** appears in the display, press the START (enter) keypad.

**NOTE: To go back to the current programmable option without changing the value, press the WARM (<) keypad.**

5. Press the DELICATES/BULKY ( $\wedge$ ) or the COLD (v) keypad to increase or decrease the value of the active digit and the START (enter) keypad to enter the value of the digit and advance to the next digit.
6. Press the START (enter) keypad when the correct value appears in the display. The new value is saved and the next option will appear in the display.

## Coin 2 Value **dEn 2**

This option allows the owner to set a specific numerical value for a coin entered when using the dual coin drop. For example, the coin value for a dollar coin would be measured in cents (1.00). Therefore, the coin value entered for one dollar coin would be 00100.

If the Vend Price #1 (option 1) is set for **200**, and the Coin Value is set for **00 100**, the vend price displayed will decrease by 1.00 for each dollar coin entered and 2 coins will need to be entered to satisfy the vend price.

1. Control must be in Manual Mode. Refer to *How to Enter the Manual Mode*.
2. Press the DELICATES/BULKY ( $\wedge$ ) or the COLD (v) keypad until **Pr09** appears in the display. Press the START (enter) keypad, and **Rt5 1** will appear in the display.
3. Press the DELICATES/BULKY ( $\wedge$ ) or the COLD (v) keypad to scroll through the programmable options until **dEn 2** appears in the display.
4. When **dEn 2** appears in the display, press the START (enter) keypad.

**NOTE: To go back to the current programmable option without changing the value, press the WARM (<) keypad.**

5. Press the DELICATES/BULKY ( $\wedge$ ) or the COLD (v) keypad to increase or decrease the value of the active digit and the START (enter) keypad to enter the value of the digit and advance to the next digit.
6. Press the START (enter) keypad when the correct value appears in the display. The new value is saved and the next option will appear in the display.

## Start Pulse Value **PL5E**

This option allows the owner to program the value of the Start Pulse if used for multiple pulses with an after-market central card reader or pay system.

1. Control must be in Manual Mode. Refer to *How to Enter the Manual Mode*.
2. Press the DELICATES/BULKY ( $\wedge$ ) or the COLD (v) keypad until **Pr09** appears in the display. Press the START (enter) keypad, and **Rt5 1** will appear in the display.
3. Press the DELICATES/BULKY ( $\wedge$ ) or the COLD (v) keypad to scroll through the programmable options until **PL5E** appears in the display.
4. When **PL5E** appears in the display, press the START (enter) keypad.

**NOTE: To go back to the current programmable option without changing the value, press the WARM (<) keypad.**

5. Press the DELICATES/BULKY ( $\wedge$ ) or the COLD (v) keypad to increase or decrease the value of the active digit and the START (enter) keypad to enter the value of the digit and advance to the next digit.
6. Press the START (enter) keypad when the correct value appears in the display. The new value is saved and the next option will appear in the display.

## Start Pulse Mode **PL5Mod**

This option allows the owner to program the Start Pulse Input. The Start Pulse Mode can be used for after-market central pay or card systems. The central system sends the start pulse to the Start Pulse Input of the control to start the cycle. If set for single pulse, one start pulse from the central system will start the cycle. If set for multiple pulses, each pulse will deduct from the vend price value set up in Start Pulse Value until the vend is satisfied.

1. Control must be in Manual Mode. Refer to *How to Enter the Manual Mode*.
2. Press the DELICATES/BULKY ( $\wedge$ ) or the COLD (v) keypad until **Pr09** appears in the display. Press the START (enter) keypad, and **Rt5 1** will appear in the display.
3. Press the DELICATES/BULKY ( $\wedge$ ) or the COLD (v) keypad to scroll through the programmable options until **PL5Mod** appears in the display.
4. When **PL5Mod** appears in the display, press the START (enter) keypad. **OFF** or a number will appear in the display. This number corresponds to the current Start Pulse Mode Programming Value.
5. Locate the desired number in the first column of *Table 1* below.

<i>PL5Mod</i>		
Start Pulse Mode Value	Start Pulse ON/OFF	Single Pulse/ Multiple Pulses
0	OFF	OFF
128 *	ON	Single Pulse
192	ON	Multiple Pulses
* Factory default setting.		

Table 1

- Press the DELICATES/BULKY (Λ) or the COLD (V) keypad to increase or decrease the current number until correct.

**NOTE: To go back to the current programmable option without changing the current value, press the WARM (<) keypad.**

- Press the START (enter) keypad when the correct value appears in the display. The new value is saved and the next option will appear in the display.

### Programmable Output Type *ALYPE*

This option allows the owner to program when the control provides an output that can be used for variety of reasons.

- Control must be in Manual Mode. Refer to *How to Enter the Manual Mode*.
- Press the DELICATES/BULKY (Λ) or the COLD (V) keypad until *Prog* appears in the display. Press the START (enter) keypad, and *AL5* will appear in the display.
- Press the DELICATES/BULKY (Λ) or the COLD (V) keypad to scroll through the programmable options until *ALYPE* appears in the display.
- When *ALYPE* appears in the display, press the START (enter) keypad. A number will appear in the display. This number corresponds to the current Output Type Value.
- Press the DELICATES/BULKY (Λ) or the COLD (V) keypad to increase or decrease the current number to the desired number selected from *Table 2*.

Programmable Output Type Value	Mode(s) in Which Available Signal is Active
0* - Available	Ready Mode only
1 - Available with Start	Ready Mode, Start Mode
2 - Available with End of Cycle	Ready Mode, End of Cycle Mode

Table 2 continues...

Programmable Output Type Value	Mode(s) in Which Available Signal is Active
3 - Available with Start and End of Cycle	Ready Mode, End of Cycle Mode, Start Mode
4 - Vend is Not Satisfied	Ready Mode, Partial Vend Mode
5 - Vend is Not Satisfied with End of Cycle	Ready Mode, Partial Vend Mode, End of Cycle Mode
6 - Available with Vend	Ready Mode, Partial Vend Mode, Start Mode
7 - Available with Vend and End of Cycle	Ready Mode, End of Cycle Mode, Partial Vend Mode, Start Mode
8 - Machine is In Use	Door Locking, Door/Lid Unlocking, Overflow Mode, Pause Mode, Run Mode
9 - Cycle is Complete	End of Cycle
10 - Lucky Cycle	For 10 seconds when Start Mode is entered
11 - Break in Alarm	For 15 seconds when Break in Alarm is triggered at same time as audio output tone
12 - End of Cycle is Entered	For 3 seconds when End of Cycle Mode is entered
13 - Motor Running	Whenever Motor is running
*Factory default setting.	

Table 2

- Press the START (enter) keypad when the correct value appears in the display. The new value is saved and the next option will appear in the display.

### Default Cycle *DFLCYC*

This option allows the owner to set the default cycle that the machine will enter when in the Ready Mode.

- Control must be in Manual Mode. Refer to *How to Enter the Manual Mode*.

2. Press the DELICATES/BULKY (Λ) or the COLD (V) keypad until **P-r-o-g** appears in the display. Press the START (enter) keypad, and **R-E-S-T** will appear in the display.
3. Press the DELICATES/BULKY (Λ) or the COLD (V) keypad to scroll through the programmable options until **dFELCYC** appears in the display.
4. When **dFELCYC** appears in the display, press the START (enter) keypad. A number will appear in the display. Refer to table below. This number corresponds to the current default cycle value. The corresponding LEDs will also be lit.

Cycle	Number on Display
NORMAL/ HOT	1
NORMAL/ WARM	2
NORMAL/ COLD	3
PERM PRESS/ HOT	4
PERM PRESS/ WARM	5
PERM PRESS/ COLD	6
DELICATES/BULKY/ HOT	7
DELICATES/BULKY/ WARM	8
DELICATES/BULKY/ COLD	9

Table 3

5. Press the DELICATES/BULKY (Λ) or the COLD (V) keypad to increase or decrease the current number to the desired number.
6. Press the START (enter) keypad when the correct value appears in the display. The new value is saved and the next option will appear in the display.

### Card Reader Display Control [C-R-d]

This option allows the owner to program whether the display is controlled by the machine’s electronic control or an external payment system such as a card reader.

**NOTE: This feature does not need to be programmed manually. The card reader itself makes this determination.**

1. Control must be in Manual Mode. Refer to *How to Enter the Manual Mode*.
2. Press the DELICATES/BULKY (Λ) or the COLD (V) keypad until **P-r-o-g** appears in the display. Press the START (enter) keypad, and **R-E-S-T** will appear in the display.

3. Press the DELICATES/BULKY (Λ) or the COLD (V) keypad to scroll through the programmable options until **C-R-d** appears in the display.
4. When **C-R-d** appears in the display, press the START (enter) keypad. The current Card Reader Display Control Status will appear in the display.

**o-n** = Card Reader/External Payment System controls display

**oFF** = Machine Electronic Control controls display (factory default setting)

5. Press the DELICATES/BULKY (Λ) or the COLD (V) keypad to change the current status.
6. Press the START (enter) keypad when the correct value appears in the display. The new value is saved and the next option will appear in the display.

### Audio Signal **AUd io**

This option allows the owner to program when the signal will sound.

There are five occasions when a signal may sound during the washer operation. These five occasions are listed below:

1. **End of Cycle Signal** By default, the signal is turned off. If turned on, the signal will sound for three seconds at the end of a cycle.
2. **Keypad Depression Signal** By default, this signal is turned on and will sound for a quarter of a second. This signal will sound each time a keypad is pressed.
3. **Coin Input/Card Insertion Signal** By default, this signal is turned on and will sound for a quarter of a second each time a coin or card is entered.
4. **Remove Card Signal (Card Models Only)** By default, this signal is turned on and will sound one second on and one second off when the control is prompting for card removal.
5. **Signal for Start** By default, this signal is turned on and will sound one second on and one second off for 10 seconds after vend price has been satisfied.

### How to Program the Audio Signal

1. Control must be in Manual Mode. Refer to *How to Enter the Manual Mode*.
2. Press the DELICATES/BULKY (Λ) or the COLD (V) keypad until **P-r-o-g** appears in the display. Press the START (enter) keypad, and **R-E-S-T** will appear in the display.
3. Press the DELICATES/BULKY (Λ) or the COLD (V) keypad to scroll through the programmable options until **AUd io** appears in the display.
4. When **AUd io** appears in the display press the START (enter) keypad. A number will appear in the display. This number corresponds to the current Audio Signal Programming Value.
5. Locate the desired number in the first column of *Table 4* on the following page.

6. Press the DELICATES/BULKY (Λ) or the COLD (V) keypad to increase or decrease the current number until correct.

For Example: A user might wish to have the signal sound only when a keypad is pressed. Entering the number “1” in step 5 would turn off all the options except KEYPAD. In this instance, the signal would sound only when a keypad is pressed.

7. Press the START (enter) keypad when the correct number appears in the display. The next option will appear in the display.

tains the number displayed on the control. The other columns correspond to individual options.

Each column of options contains a unique combination of the words “ON” and “OFF” that indicates if that column’s option is turned on or off when the Signal Value is entered. Select the desired combination of options and enter the number found in the Signal Value column.

The default value programmed at the factory is 29.

### How to Read Audio Signal Table

To determine the correct number required to program the Audio Signal, use the following chart. The Signal Value column con-

Signal Value	Start Mode	Serial or Network Vending Command Signal	Coin/Card Input	End of Cycle	Key Pressed
0	OFF	OFF	OFF	OFF	OFF
1	OFF	OFF	OFF	OFF	<b>ON</b>
2	OFF	OFF	OFF	<b>ON</b>	OFF
3	OFF	OFF	OFF	<b>ON</b>	<b>ON</b>
4	OFF	OFF	<b>ON</b>	OFF	OFF
5	OFF	OFF	<b>ON</b>	OFF	<b>ON</b>
6	OFF	OFF	<b>ON</b>	<b>ON</b>	OFF
7	OFF	OFF	<b>ON</b>	<b>ON</b>	<b>ON</b>
8	OFF	<b>ON</b>	OFF	OFF	OFF
9	OFF	<b>ON</b>	OFF	OFF	<b>ON</b>
10	OFF	<b>ON</b>	OFF	<b>ON</b>	OFF
11	OFF	<b>ON</b>	OFF	<b>ON</b>	<b>ON</b>
12	OFF	<b>ON</b>	<b>ON</b>	OFF	OFF
13	OFF	<b>ON</b>	<b>ON</b>	OFF	<b>ON</b>
14	OFF	<b>ON</b>	<b>ON</b>	<b>ON</b>	OFF
15	OFF	<b>ON</b>	<b>ON</b>	<b>ON</b>	<b>ON</b>
16	<b>ON</b>	OFF	OFF	OFF	OFF
17	<b>ON</b>	OFF	OFF	OFF	<b>ON</b>
18	<b>ON</b>	OFF	OFF	<b>ON</b>	OFF

Table 4 continues...



Signal Value	Start Mode	Serial or Network Vending Command Signal	Coin/Card Input	End of Cycle	Key Pressed
19	ON	OFF	OFF	ON	ON
20	ON	OFF	ON	OFF	OFF
21	ON	OFF	ON	OFF	ON
22	ON	OFF	ON	ON	OFF
23	ON	OFF	ON	ON	ON
24	ON	ON	OFF	OFF	OFF
25	ON	ON	OFF	OFF	ON
26	ON	ON	OFF	ON	OFF
27	ON	ON	OFF	ON	ON
28	ON	ON	ON	OFF	OFF
29*	ON	ON	ON	OFF	ON
30	ON	ON	ON	ON	OFF
31	ON	ON	ON	ON	ON

\* Factory default setting.

Table 4

## Network Node Number *node*

This option allows the owner to program a unique number used for wired or wireless communication. Every machine on the same network must have a different node number to work correctly.

- Control must be in Manual Mode. Refer to *How to Enter the Manual Mode*.
- Press the DELICATES/BULKY ( $\Lambda$ ) or the COLD (V) keypad until *Prog* appears in the display. Press the START (enter) keypad, and *NET 1* will appear in the display.
- Press the DELICATES/BULKY ( $\Lambda$ ) or the COLD (V) keypad to scroll through the programmable options until *node* appears in the display.
- When *node* appears in the display, press the START (enter) keypad. The current Network Node Number status will appear in the display.
- Press the DELICATES/BULKY ( $\Lambda$ ) or the COLD (V) keypad to change the current status.
- Press the START (enter) keypad when the correct value appears in the display. The new value is saved and the next option will appear in the display.

## Error Code Programming *Error-*

This option allows the owner to turn on or turn off certain errors in the control.

- Control must be in Manual Mode. Refer to *How to Enter the Manual Mode*.
- Press the DELICATES/BULKY ( $\Lambda$ ) or the COLD (V) keypad until *Prog* appears in the display. Press the START (enter) keypad, and *NET 1* will appear in the display.
- Press the DELICATES/BULKY ( $\Lambda$ ) or the COLD (V) keypad to scroll through the programmable options until *Error-* appears in the display.
- When *Error-* appears in the display, press the START (enter) keypad. There are multiple programmable error code parameters. Refer to *Table 5*.
- Press the DELICATES/BULKY ( $\Lambda$ ) or the COLD (V) keypad to select the desired option.
- Press the DELICATES/BULKY ( $\Lambda$ ) or the COLD (V) keypad to select error code.

7. Press the START (enter) keypad when the correct code appears in the display. The current status will appear in the display.

**NOTE: Press the DELICATES/BULKY (Λ) or the COLD (V) keypad and then the START (enter) keypad again to choose a specific coin error parameter. Refer to Table 5 .**

8. Press the DELICATES/BULKY (Λ ) or the COLD (V) keypad to change the status.  
 9. Press the START (enter) keypad when the correct status appears in the display. The next Error Code Programming option will appear in the display.

Error Code Programming <i>Error-</i>		
<i>CErr-</i>	Coin Error Parameters Menu	
	<i>CEr 1</i>	Coin Error - Determines if display will show error.
	<i>CEr 2</i>	Coin Error Penalty - If enabled, coin error will erase previous coins entered and reset the vend price.
	<i>CEr 3</i>	Vend Header Present Error - If enabled and coin drop header is unplugged, control ignores coin inputs.
<i>E FL-</i>	Fill Error Menu	
	<i>E FL 1</i>	Fill Error (On/Off) - If Enabled, will set error after fill error alarm time if fill level isn't reached, if disabled will allow filling forever if fill level never reached.
	<i>E FL 2</i>	Fill Error Time - Time allowed in minutes to reach target fill level before setting a fill error.
<i>E nF-</i>	No Water Flow Error Menu	
	<i>E nF 1</i>	No Water Flow Error (On/Off) - If Enabled, will set error after no water flow error time if 4 inch water level isn't reached. If disabled will allow filling forever until 4 inch level is reached.
	<i>E nF 2</i>	No Water Flow Error Time - Time allowed in minutes to reach a 4 inch fill level.
<i>E dr-</i>	Drain Error Menu	
	<i>E dr 1</i>	Drain Error (On/Off) - If Enabled, will set error after drain error alarm time if empty water level isn't reached, if disabled will allow draining forever if empty level never reached.

Table 5 *continues...*

Error Code Programming <i>Error</i>		
	<i>E dr 2</i>	Drain Error Time - Time allowed in minutes to reach an empty water level before setting the drain error.
<i>E Ld-</i>	<i>E Ld-</i>	Water Leak Detection Error Menu - This error checks for whether the machine is leaking water by adding 1 minute to the cycle to check for water leaks.
	<i>E Ld 1</i>	Water Leak Detection Day(s) of Week Enable - Allows owner to pick which days to check for water leaks.  Refer to <i>Table 8</i> for the value definitions.
	<i>E Ld 2</i>	Water Leak Detection Number of Cycles Between - Sets how many cycles must run before water leaks are checked again.
	<i>E Ld 3</i>	Water Leak Detection Display Sequence (On/Off) - Will show a moving dash "-" across the 7-segment display while the water leak detection is being performed.
<i>E 5d-</i>	Slow Drain Detection Error Menu	
	<i>E 5d 1</i>	Slow Drain Detection (On/Off) - Enables/Disables the error
	<i>E 5d 2</i>	Slow Drain Detection Adjust - Allows the owner to add time in seconds to the machine's default draining time used to detect for slow draining conditions. Helps allow for locations with poor draining conditions.
<i>E Ub</i>	<i>E Ub</i>	Non-Fatal Unbalance Error - Error shown at end of cycle if load has been detected to be out of balance during the cycle. Shown after the door is opened or a key is pressed. This error will remain displayed until another key has been pressed or one minute passes.
<i>E 5L</i>	<i>E 5L</i>	Suds Lock Error Display - Shown at end of cycle after the door is opened or a key is pressed if suds were still detected in the machine after all Suds Removal Routines allowed have been run in the cycle. Will be cleared after one minute or if a key is pressed.

Table 5 *continues...*

Error Code Programming <i>Error</i>		
<i>SUd-</i>	Suds Removal Routine Menu	
	<i>SUd 1</i>	Suds Removal Routine Display (On/Off)- Will show "SUdS" on the display while a Suds Removal Routine is being performed during the cycle.
	<i>SUd 2</i>	Suds Removal Routine Allowed Per Cycle - Allows the owner to pick how many Suds Removal Routines are allowed per cycle.
	<i>SUd 3</i>	Suds Removal Routine Extra Time (On/Off) - If programmed to ON, the Suds Removal Routines will pause cycle time to perform suds removal routines, if Off, the Suds Removal Routines will use cycle time which may result in poorer machine performance.
<i>ourFLd</i>	<i>ourFLd</i>	Overflow Mode Display - Can be used to disable "oFLo" on the display while in an Overflow Condition during a running cycle if set to Off. In all other modes, it will always show "oFLo" if an overflow condition exists.
<i>CLrErr</i>	<i>CLrErr</i>	Allow Error Clearing (On/Off) - Allows the ability for the owner to clear most errors by pressing NORMAL PERM PRESS keypads. Some errors will still require power to be cycled to clear the error and some errors will continually set themselves until the condition for the error being set is fixed. Call for service if an error will not clear.

Table 5

## Low Water Level *FL Lo*

This option allows the owner to set the low water level which can be used in fill steps to set water levels in cycle programming.

1. Control must be in Manual Mode. Refer to *How to Enter the Manual Mode*.
2. Press the DELICATES/BULKY (Λ) or the COLD (V) keypad until *Pr09* appears in the display. Press the START (enter) keypad, and *FL 1* will appear in the display.
3. Press the DELICATES/BULKY (Λ) or the COLD (V) keypad to scroll through the programmable options until *FL Lo* appears in the display.

4. When *FL Lo* appears in the display, press the START (enter) keypad. A number will appear in the display. This number corresponds to the current Water Level setting.
5. Press the DELICATES/BULKY (Λ) or the COLD (V) keypad to change the current status.
6. Press the START (enter) keypad when the correct value appears in the display. The new value is saved and the next option will appear in the display.

## Medium Water Level *FL MED*

This option allows the owner to set the medium water level which can be used in fill steps to set water levels in cycle programming.

1. Control must be in Manual Mode. Refer to *How to Enter the Manual Mode*.
2. Press the DELICATES/BULKY (Λ) or the COLD (V) keypad until **PrOG** appears in the display. Press the START (enter) keypad, and **RL5 I** will appear in the display.
3. Press the DELICATES/BULKY (Λ) or the COLD (V) keypad to scroll through the programmable options until **FL NEd** appears in the display.
4. When **FL NEd** appears in the display, press the START (enter) keypad. A number will appear in the display. This number corresponds to the current Water Level setting.
5. Press the DELICATES/BULKY (Λ) or the COLD (V) keypad to change the current status.
6. Press the START (enter) keypad when the correct value appears in the display. The new value is saved and the next option will appear in the display.

## High Water Level **FL H I**

This option allows the owner to set the high water level which can be used in fill steps to set water levels in cycle programming.

1. Control must be in Manual Mode. Refer to *How to Enter the Manual Mode*.
2. Press the DELICATES/BULKY (Λ) or the COLD (V) keypad until **PrOG** appears in the display. Press the START (enter) keypad, and **RL5 I** will appear in the display.
3. Press the DELICATES/BULKY (Λ) or the COLD (V) keypad to scroll through the programmable options until **FL H I** appears in the display.
4. When **FL H I** appears in the display, press the START (enter) keypad. A number will appear in the display. This number corresponds to the current Water Level setting.
5. Press the DELICATES/BULKY (Λ) or the COLD (V) keypad to change the current status.
6. Press the START (enter) keypad when the correct value appears in the display. The new value is saved and the next option will appear in the display.

## Flush Out Time for Fill Step **FLSH t**

This option allows the owner to set the flush out time in seconds for fill steps that have flush out enabled. The flush out is used to help rinse out the machine at the beginning of the fill steps. The water will be evacuated for the programmed time at the beginning of the fill steps that have this option enabled.

1. Control must be in Manual Mode. Refer to *How to Enter the Manual Mode*.
2. Press the DELICATES/BULKY (Λ) or the COLD (V) keypad until **PrOG** appears in the display. Press the START (enter) keypad, and **RL5 I** will appear in the display.
3. Press the DELICATES/BULKY (Λ) or the COLD (V) keypad to scroll through the programmable options until **FLSH t** appears in the display.
4. When **FLSH t** appears in the display, press the START (enter) keypad. A number will appear in the display. This number corresponds to the current setting.
5. Press the DELICATES/BULKY (Λ) or the COLD (V) keypad to change the current status.
6. Press the START (enter) keypad when the correct value appears in the display. The new value is saved and the next option will appear in the display.

## No Refill After Time for Agitate Step **norF t**

This option allows the owner to set the no refill after time in minutes for fill, agitate, and soak steps. Refills can only occur if the programmed time has not been exceeded in the current step.

1. Control must be in Manual Mode. Refer to *How to Enter the Manual Mode*.
2. Press the DELICATES/BULKY (Λ) or the COLD (V) keypad until **PrOG** appears in the display. Press the START (enter) keypad, and **RL5 I** will appear in the display.
3. Press the DELICATES/BULKY (Λ) or the COLD (V) keypad to scroll through the programmable options until **norF** appears in the display.
4. When **norF** appears in the display, press the START (enter) keypad. A number will appear in the display. This number corresponds to the current setting.
5. Press the DELICATES/BULKY (Λ) or the COLD (V) keypad to change the current status.
6. Press the START (enter) keypad when the correct value appears in the display. The new value is saved and the next option will appear in the display.

## Set Real-Time Clock **r-t[-**

This option allows the owner to set the controls internal clock to the correct time and date.

1. Control must be in Manual Mode. Refer to *How to Enter the Manual Mode*.

- Press the DELICATES/BULKY (Λ) or the COLD (V) keypad until **P r o g** appears in the display. Press the START (enter) keypad, and **RL5 1** will appear in the display.
- Press the DELICATES/BULKY (Λ) or the COLD (V) keypad to scroll through the programmable options until **RLC -** appears in the display.
- Press the START keypad and **RLC 1** will appear in the display.
- Press the DELICATES/BULKY (Λ) or the COLD (V) keypad to scroll through the programmable options. Refer to *Table 6*.

<b>RLC 1</b>	Programs Minutes
<b>RLC 2</b>	Programs Hours
<b>RLC 3</b>	Programs Day of Week
<b>RLC 4</b>	Programs Date of Month
<b>RLC 5</b>	Programs Month
<b>RLC 6</b>	Programs Year

Table 6

- When the desired option appears in the display, press the START (enter) keypad. The current value will appear in the display.
- Press the DELICATES/BULKY (Λ) or the COLD (V) keypad to increase or decrease the minutes, hours, day of week, date of month, month or year to the correct time or date.  
**NOTE: The hours will be displayed in military time. For day of week, Sunday is considered day one (1), Monday is day two (2) and so on. For year, the year 2000 is " 0 ", the year 2001 is " 1 " and so on.**
- Press the START (enter) keypad when the correct value appears in the display. The new value is saved and the next option will appear in the display.

### Set Daylight Savings Time **dL 5 -**

This option allows the owner to set the controls internal clock to the daylight savings time and date.

- Control must be in Manual Mode. Refer to *How to Enter the Manual Mode*.
- Press the DELICATES/BULKY (Λ) or the COLD (V) keypad until **P r o g** appears in the display. Press the START (enter) keypad, and **RL5 1** will appear in the display.
- Press the DELICATES/BULKY (Λ) or the COLD (V) keypad to scroll through the programmable options until **dL 5 -** appears in the display. Press the START keypad and **dL 5 1** will appear in the display.
- Press the DELICATES/BULKY (Λ) or the COLD (V) keypad to scroll through the programmable options. Refer to *Table 7*.

<b>dL 5 1</b>	Daylight Savings (On/Off)
<b>dL 5 2</b>	Programs Start Month
<b>dL 5 3</b>	Programs Start Day of Week
<b>dL 5 4</b>	Programs Start Week of Month
<b>dL 5 5</b>	Programs Start Hour
<b>dL 5 6</b>	Programs End Month
<b>dL 5 7</b>	Programs End Day of Week
<b>dL 5 8</b>	Programs End Week of Month
<b>dL 5 9</b>	Programs End Hour

Table 7

- When the desired option appears in the display, press the START (enter) keypad. The current value will appear in the display.
- Press the DELICATES/BULKY (Λ) or the COLD (V) keypad to increase or decrease the minutes, hours, day of week, date of month, month or year to the correct time or date.  
**NOTE: The hours will be displayed in military time. For day of week, Sunday is considered day one (1), Monday is day two (2) and so on. For year, the year 2000 is " 0 ", the year 2001 is " 1 " and so on. For week of month, first week is "1", second week is "2", third week is "3", and last week is "4".**
- Press the START (enter) keypad when the correct value appears in the display. The new value is saved and the next option will appear in the display.

### Special Vend 1 Days Enable **SP 1 1**

This option allows the owner to set the day or days of a special vend.

Special Vend 1 is used to change the standard vend prices for special occasions. The special vend can be programmed to start and end on a specific day or days of the week.

The owner may also turn the Special Vend 1 option on or off if desired.

- Control must be in Manual Mode. Refer to *How to Enter the Manual Mode*.
- Press the DELICATES/BULKY (Λ) or the COLD (V) keypad until **P r o g** appears in the display. Press the START (enter) keypad, and **RL5 1** will appear in the display.

3. Press the DELICATES/BULKY (Λ) or the COLD (V) keypad to scroll through the programmable options until **SP 1-** appears in the display. Press the START (enter) keypad and **SP 1 /** will appear in the display.
4. When **SP 1 /** appears in the display, press the START (enter) keypad. A number will appear in the display that corresponds to the current Special Vend 1 Days Enable Programming Value.
5. Locate the desired number in the first column of *Table 8*.
6. Press the DELICATES/BULKY (Λ) or the COLD (V) keypad to increase or decrease the current number until correct.
7. Press the START (enter) keypad when the correct value appears in the display. The new value is saved and the next option will appear in the display.

### How to Read the Days Enable Value Table

To determine the correct number required to program the Special Vend Days Enable, Water Leak Detection Days of Week Enable or the Lucky Cycle Day(s) of Week / Enable, use the following table.

The Value column contains the number required in step 6. The other columns correspond to individual days.

Each column of days contains a unique combination of the words “ON” and “OFF” that indicates if that column’s day is turned on or off when the value is entered. Select the desired combination of days and enter the number found in the value column.

\* The default value programmed at the factory is 0.

<b>SP 1 /, E Ld / and LUC /</b>								
<b>VALUE</b>	<b>SAT</b>	<b>FRI</b>	<b>THUR</b>	<b>WED</b>	<b>TUE</b>	<b>MON</b>	<b>SUN</b>	<b>ON/OFF</b>
0*	OFF	OFF	OFF	OFF	OFF	OFF	OFF	OFF
3	OFF	OFF	OFF	OFF	OFF	OFF	ON	ON
5	OFF	OFF	OFF	OFF	OFF	ON	OFF	ON
7	OFF	OFF	OFF	OFF	OFF	ON	ON	ON
9	OFF	OFF	OFF	OFF	ON	OFF	OFF	ON
11	OFF	OFF	OFF	OFF	ON	OFF	ON	ON
13	OFF	OFF	OFF	OFF	ON	ON	OFF	ON
15	OFF	OFF	OFF	OFF	ON	ON	ON	ON
17	OFF	OFF	OFF	ON	OFF	OFF	OFF	ON
19	OFF	OFF	OFF	ON	OFF	OFF	ON	ON
21	OFF	OFF	OFF	ON	OFF	ON	OFF	ON
23	OFF	OFF	OFF	ON	OFF	ON	ON	ON
25	OFF	OFF	OFF	ON	ON	OFF	OFF	ON
27	OFF	OFF	OFF	ON	ON	OFF	ON	ON
29	OFF	OFF	OFF	ON	ON	ON	OFF	ON
31	OFF	OFF	OFF	ON	ON	ON	ON	ON
33	OFF	OFF	ON	OFF	OFF	OFF	OFF	ON
35	OFF	OFF	ON	OFF	OFF	OFF	ON	ON

Table 8 continues...

<i>SPI 1, E Ld 1 and LUC 1</i>								
<b>VALUE</b>	<b>SAT</b>	<b>FRI</b>	<b>THUR</b>	<b>WED</b>	<b>TUE</b>	<b>MON</b>	<b>SUN</b>	<b>ON/OFF</b>
37	OFF	OFF	<b>ON</b>	OFF	OFF	<b>ON</b>	OFF	<b>ON</b>
39	OFF	OFF	<b>ON</b>	OFF	OFF	<b>ON</b>	<b>ON</b>	<b>ON</b>
41	OFF	OFF	<b>ON</b>	OFF	<b>ON</b>	OFF	OFF	<b>ON</b>
43	OFF	OFF	<b>ON</b>	OFF	<b>ON</b>	OFF	<b>ON</b>	<b>ON</b>
45	OFF	OFF	<b>ON</b>	OFF	<b>ON</b>	<b>ON</b>	OFF	<b>ON</b>
47	OFF	OFF	<b>ON</b>	OFF	<b>ON</b>	<b>ON</b>	<b>ON</b>	<b>ON</b>
49	OFF	OFF	<b>ON</b>	<b>ON</b>	OFF	OFF	OFF	<b>ON</b>
51	OFF	OFF	<b>ON</b>	<b>ON</b>	OFF	OFF	<b>ON</b>	<b>ON</b>
53	OFF	OFF	<b>ON</b>	<b>ON</b>	OFF	<b>ON</b>	OFF	<b>ON</b>
55	OFF	OFF	<b>ON</b>	<b>ON</b>	OFF	<b>ON</b>	<b>ON</b>	<b>ON</b>
57	OFF	OFF	<b>ON</b>	<b>ON</b>	<b>ON</b>	OFF	OFF	<b>ON</b>
59	OFF	OFF	<b>ON</b>	<b>ON</b>	<b>ON</b>	OFF	<b>ON</b>	<b>ON</b>
61	OFF	OFF	<b>ON</b>	<b>ON</b>	<b>ON</b>	<b>ON</b>	OFF	<b>ON</b>
63	OFF	OFF	<b>ON</b>	<b>ON</b>	<b>ON</b>	<b>ON</b>	<b>ON</b>	<b>ON</b>
65	OFF	<b>ON</b>	OFF	OFF	OFF	OFF	OFF	<b>ON</b>
67	OFF	<b>ON</b>	OFF	OFF	OFF	OFF	<b>ON</b>	<b>ON</b>
69	OFF	<b>ON</b>	OFF	OFF	OFF	<b>ON</b>	OFF	<b>ON</b>
71	OFF	<b>ON</b>	OFF	OFF	OFF	<b>ON</b>	<b>ON</b>	<b>ON</b>
73	OFF	<b>ON</b>	OFF	OFF	<b>ON</b>	OFF	OFF	<b>ON</b>
75	OFF	<b>ON</b>	OFF	OFF	<b>ON</b>	OFF	<b>ON</b>	<b>ON</b>
77	OFF	<b>ON</b>	OFF	OFF	<b>ON</b>	<b>ON</b>	OFF	<b>ON</b>
79	OFF	<b>ON</b>	OFF	OFF	<b>ON</b>	<b>ON</b>	<b>ON</b>	<b>ON</b>
81	OFF	<b>ON</b>	OFF	<b>ON</b>	OFF	OFF	OFF	<b>ON</b>
83	OFF	<b>ON</b>	OFF	<b>ON</b>	OFF	OFF	<b>ON</b>	<b>ON</b>
85	OFF	<b>ON</b>	OFF	<b>ON</b>	OFF	<b>ON</b>	OFF	<b>ON</b>
87	OFF	<b>ON</b>	OFF	<b>ON</b>	OFF	<b>ON</b>	<b>ON</b>	<b>ON</b>

Table 8 *continues...*



<i>SPI 1, E Ld 1 and LUC 1</i>								
<b>VALUE</b>	<b>SAT</b>	<b>FRI</b>	<b>THUR</b>	<b>WED</b>	<b>TUE</b>	<b>MON</b>	<b>SUN</b>	<b>ON/OFF</b>
89	OFF	ON	OFF	ON	ON	OFF	OFF	ON
91	OFF	ON	OFF	ON	ON	OFF	ON	ON
93	OFF	ON	OFF	ON	ON	ON	OFF	ON
95	OFF	ON	OFF	ON	ON	ON	ON	ON
97	OFF	ON	ON	OFF	OFF	OFF	OFF	ON
99	OFF	ON	ON	OFF	OFF	OFF	ON	ON
101	OFF	ON	ON	OFF	OFF	ON	OFF	ON
103	OFF	ON	ON	OFF	OFF	ON	ON	ON
105	OFF	ON	ON	OFF	ON	OFF	OFF	ON
107	OFF	ON	ON	OFF	ON	OFF	ON	ON
109	OFF	ON	ON	OFF	ON	ON	OFF	ON
111	OFF	ON	ON	OFF	ON	ON	ON	ON
113	OFF	ON	ON	ON	OFF	OFF	OFF	ON
115	OFF	ON	ON	ON	OFF	OFF	ON	ON
117	OFF	ON	ON	ON	OFF	ON	OFF	ON
119	OFF	ON	ON	ON	OFF	ON	ON	ON
121	OFF	ON	ON	ON	ON	OFF	OFF	ON
123	OFF	ON	ON	ON	ON	OFF	ON	ON
125	OFF	ON	ON	ON	ON	ON	OFF	ON
127	OFF	ON	ON	ON	ON	ON	ON	ON
129	ON	OFF	OFF	OFF	OFF	OFF	OFF	ON
131	ON	OFF	OFF	OFF	OFF	OFF	ON	ON
133	ON	OFF	OFF	OFF	OFF	ON	OFF	ON
135	ON	OFF	OFF	OFF	OFF	ON	ON	ON
137	ON	OFF	OFF	OFF	ON	OFF	OFF	ON
139	ON	OFF	OFF	OFF	ON	OFF	ON	ON

Table 8 *continues...*

<i>SPI 1, E Ld 1 and LUC 1</i>								
<b>VALUE</b>	<b>SAT</b>	<b>FRI</b>	<b>THUR</b>	<b>WED</b>	<b>TUE</b>	<b>MON</b>	<b>SUN</b>	<b>ON/OFF</b>
141	ON	OFF	OFF	OFF	ON	ON	OFF	ON
143	ON	OFF	OFF	OFF	ON	ON	ON	ON
145	ON	OFF	OFF	ON	OFF	OFF	OFF	ON
147	ON	OFF	OFF	ON	OFF	OFF	ON	ON
149	ON	OFF	OFF	ON	OFF	ON	OFF	ON
151	ON	OFF	OFF	ON	OFF	ON	ON	ON
153	ON	OFF	OFF	ON	ON	OFF	OFF	ON
155	ON	OFF	OFF	ON	ON	OFF	ON	ON
157	ON	OFF	OFF	ON	ON	ON	OFF	ON
159	ON	OFF	OFF	ON	ON	ON	ON	ON
161	ON	OFF	ON	OFF	OFF	OFF	OFF	ON
163	ON	OFF	ON	OFF	OFF	OFF	ON	ON
165	ON	OFF	ON	OFF	OFF	ON	OFF	ON
167	ON	OFF	ON	OFF	OFF	ON	ON	ON
169	ON	OFF	ON	OFF	ON	OFF	OFF	ON
171	ON	OFF	ON	OFF	ON	OFF	ON	ON
173	ON	OFF	ON	OFF	ON	ON	OFF	ON
175	ON	OFF	ON	OFF	ON	ON	ON	ON
177	ON	OFF	ON	ON	OFF	OFF	OFF	ON
179	ON	OFF	ON	ON	OFF	OFF	ON	ON
181	ON	OFF	ON	ON	OFF	ON	OFF	ON
183	ON	OFF	ON	ON	OFF	ON	ON	ON
185	ON	OFF	ON	ON	ON	OFF	OFF	ON
187	ON	OFF	ON	ON	ON	OFF	ON	ON
189	ON	OFF	ON	ON	ON	ON	OFF	ON
191	ON	OFF	ON	ON	ON	ON	ON	ON

Table 8 *continues...*

<i>SPI 1, E Ld 1 and LUC 1</i>								
<b>VALUE</b>	<b>SAT</b>	<b>FRI</b>	<b>THUR</b>	<b>WED</b>	<b>TUE</b>	<b>MON</b>	<b>SUN</b>	<b>ON/OFF</b>
193	ON	ON	OFF	OFF	OFF	OFF	OFF	ON
195	ON	ON	OFF	OFF	OFF	OFF	ON	ON
197	ON	ON	OFF	OFF	OFF	ON	OFF	ON
199	ON	ON	OFF	OFF	OFF	ON	ON	ON
201	ON	ON	OFF	OFF	ON	OFF	OFF	ON
203	ON	ON	OFF	OFF	ON	OFF	ON	ON
205	ON	ON	OFF	OFF	ON	ON	OFF	ON
207	ON	ON	OFF	OFF	ON	ON	ON	ON
209	ON	ON	OFF	ON	OFF	OFF	OFF	ON
211	ON	ON	OFF	ON	OFF	OFF	ON	ON
213	ON	ON	OFF	ON	OFF	ON	OFF	ON
215	ON	ON	OFF	ON	OFF	ON	ON	ON
217	ON	ON	OFF	ON	ON	OFF	OFF	ON
219	ON	ON	OFF	ON	ON	OFF	ON	ON
221	ON	ON	OFF	ON	ON	ON	OFF	ON
223	ON	ON	OFF	ON	ON	ON	ON	ON
225	ON	ON	ON	OFF	OFF	OFF	OFF	ON
227	ON	ON	ON	OFF	OFF	OFF	ON	ON
229	ON	ON	ON	OFF	OFF	ON	OFF	ON
231	ON	ON	ON	OFF	OFF	ON	ON	ON
233	ON	ON	ON	OFF	ON	OFF	OFF	ON
235	ON	ON	ON	OFF	ON	OFF	ON	ON
237	ON	ON	ON	OFF	ON	ON	OFF	ON
239	ON	ON	ON	OFF	ON	ON	ON	ON
241	ON	ON	ON	ON	OFF	OFF	OFF	ON
243	ON	ON	ON	ON	OFF	OFF	ON	ON

Table 8 *continues...*

SP 1 1, E Ld 1 and LUC 1								
VALUE	SAT	FRI	THUR	WED	TUE	MON	SUN	ON/OFF
245	ON	ON	ON	ON	OFF	ON	OFF	ON
247	ON	ON	ON	ON	OFF	ON	ON	ON
249	ON	ON	ON	ON	ON	OFF	OFF	ON
251	ON	ON	ON	ON	ON	OFF	ON	ON
253	ON	ON	ON	ON	ON	ON	OFF	ON
255	ON	ON	ON	ON	ON	ON	ON	ON

\* Factory default setting.

Table 8

### How to Program Special Vend 1 Start Minute SP 1 2

This option allows the owner to set the minute that Special Vend 1 will begin.

1. Press the DELICATES/BULKY (Λ) or the COLD (V) keypad to scroll through the programmable Special Vend 1 options until SP 1 2 appears in the display.
2. When SP 1 2 appears in the display, press the START (enter) keypad. The current start minute will appear in the display.
3. Press the DELICATES/BULKY (Λ) or the COLD (V) keypad to increase or decrease the value to the desired minute.
4. Press the START (enter) keypad when the correct value appears in the display. The new value is saved and the next option will appear in the display.

### How to Program Special Vend 1 Start Hour SP 1 3

This option allows the owner to set the hour that Special Vend 1 will begin.

1. Press the DELICATES/BULKY (Λ) or the COLD (V) keypad to scroll through the programmable Special Vend 1 options until SP 1 3 appears in the display.
2. When SP 1 3 appears in the display, press the START (enter) keypad. The current start time (in military time) will appear in the display.

**NOTE: The hours will be displayed in military time.**

3. Press the DELICATES/BULKY (Λ) or the COLD (V) keypad to increase or decrease the start value to the desired hour.
4. Press the START (enter) keypad when the correct value appears in the display. The new value is saved and the next option will appear in the display.

### How to Program Special Vend 1 Start Date SP 1 4

This option allows the owner to set the date of the month that Special Vend 1 will begin.

1. Press the DELICATES/BULKY (Λ) or the COLDD (V) keypad to scroll through the programmable Special Vend 1 options until SP 1 4 appears in the display.
2. When SP 1 4 appears in the display, press the START (enter) keypad. The current start date will appear in the display.
3. Press the DELICATES/BULKY (Λ) or the COLD (V) keypad to increase or decrease the start date to the desired date.

**NOTE: If "off" is selected and Special Vend 1 is on, Special Vend 1 will occur at the time and days of week selected, regardless of the date.**

4. Press the START (enter) keypad when the correct value appears in the display. The new value is saved and the next option will appear in the display.

### How to Program Special Vend 1 Start Month SP 1 5

This option allows the owner to set the month that Special Vend 1 will begin.

**NOTE: If Special Vend 1 Start Month, Start Date, End Month, or End Date are programmed to zero (default is zero), the Special Vend 1 will be active every week on the days programmed in Table 8.**

1. Press the DELICATES/BULKY (Λ) or the COLD (V) keypad to scroll through the programmable Special Vend 1 options until SP 1 5 appears in the display.
2. When SP 1 5 appears in the display, press the START (enter) keypad. The current start month will appear in the display.
3. Press the DELICATES/BULKY (Λ) or the COLD (V) keypad to increase or decrease the start month to the desired month.

**NOTE: If “off” is selected and Special Vend 1 is on, Special Vend 1 will occur at the time and days of week selected, regardless of the month.**

4. Press the START (enter) keypad when the correct value appears in the display. The new value is saved and the next option will appear in the display.

### How to Program Special Vend 1 Start Year *SP I 5*

This option allows the owner to set the year that Special Vend 1 will begin.

1. Press the DELICATES/BULKY (Λ) or the COLD (V) keypad to scroll through the programmable Special Vend 1 options until *SP I 5* appears in the display.
2. When *SP I 5* appears in the display, press the START (enter) keypad. The current start year will appear in the display.
3. Press the DELICATES/BULKY (Λ) or the COLD (V) keypad to increase or decrease the start value to the desired year.

**NOTE: If “off” is selected and Special Vend 1 is on, Special Vend 1 will occur at the time or days of week selected, regardless of the year. “1” is year 2001, “2” is year 2002, and so on.**

4. Press the START (enter) keypad when the correct value appears in the display. The new value is saved and the next option will appear in the display.

### How to Program Special Vend 1 Length in Hours *SP I 7*

This option allows the owner to set the length in hours for Special Vend 1.

1. Press the DELICATES/BULKY (Λ) or the COLD (V) keypad to scroll through the programmable Special Vend 1 options until *SP I 7* appears in the display.
2. When *SP I 7* appears in the display, press the START (enter) keypad. The current length in hours will appear in the display.
3. Press the DELICATES/BULKY (Λ) or the COLD (V) keypad to increase or decrease the current value to the desired number of hours.
4. Press the START (enter) keypad when the correct value appears in the display. The new value is saved and the next option will appear in the display.

### How to Program Special Vend 1 End Date *SP I 8*

This option allows the owner to set the date of the month that Special Vend 1 will end.

1. Press the DELICATES/BULKY (Λ) or the COLD (V) keypad to scroll through the programmable Special Vend 1 options until *SP I 8* appears in the display.
2. When *SP I 8* appears in the display, press the START (enter) keypad. The current end date will appear in the display.
3. Press the DELICATES/BULKY (Λ) or the COLD (V) keypad to increase or decrease the value to the desired date.

**NOTE: If “off” is selected and Special Vend 1 is on, Special Vend 1 will occur at the time or days of week selected, regardless of the date.**

4. Press the START (enter) keypad when the correct value appears in the display. The new value is saved and the next option will appear in the display.

### How to Program Special Vend 1 End Month *SP I 9*

This option allows the owner to set the month that Special Vend 1 will end.

1. Press the DELICATES/BULKY (Λ) or the COLD (V) keypad to scroll through the programmable Special Vend 1 options until *SP I 9* appears in the display.
2. When *SP I 9* appears in the display, press the START (enter) keypad. The current end month will appear in the display.
3. Press the DELICATES/BULKY (Λ) or the COLD (V) keypad to increase or decrease the value to the desired month.

**NOTE: If “off” is selected and Special Vend 1 is on, Special Vend 1 will occur at the time and day of week selected, regardless of the month.**

4. Press the START (enter) keypad when the correct value appears in the display. The new value is saved and the next option will appear in the display.

### How to Program Special Vend 1 End Year *SP I 10*

This option allows the owner to set the year that Special Vend 1 will end.

1. Press the DELICATES/BULKY (Λ) or the COLD (V) keypad to scroll through the programmable Special Vend 1 options until *SP I 10* appears in the display.
2. When *SP I 10* appears in the display, press the START (enter) keypad. The current end year will appear in the display.
3. Press the DELICATES/BULKY (Λ) or the COLD (V) keypad to increase or decrease the value to the desired year.

**NOTE: If “off” is selected and Special Vend 1 is on, Special Vend 1 will occur at the time or days of week selected, regardless of the year. “1” is year 2001, “2” is year 2002 and so on.**

4. Press the START (enter) keypad when the correct value appears in the display. The new value is saved and the next option will appear in the display.

### How to Program Special Vend 1 Vend Price 1 *SP I 11*

This option allows the owner to set the vend price for all cycles, but otherwise specifically for NORMAL HOT. This price should be set before all other prices. The corresponding LEDs will be lit while programming.

1. Press the DELICATES/BULKY (Λ) or the COLD (V) keypad to scroll through the programmable Special Vend 1 options until *SP I 11* appears in the display.

2. When **SP 1 11** appears in the display, press the START (enter) keypad. The current value will appear in the display.

**NOTE: To go back to the current programmable Special Vend 1 option without changing the value, press the WARM (<) keypad.**

3. Press the DELICATES/BULKY (Λ) or the COLD (V) keypad to increase or decrease the value of the active digit and the START keypad to enter the value of the digit and advance to the next digit.
4. Press the START (enter) keypad when the correct value appears in the display. The new value is saved and the next option will appear in the display.

### How to Program Special Vend 1 Vend Price 2

#### SP 1 12

This option allows the owner to set the vend price for a NORMAL WARM wash in Special Vend 1. The corresponding LEDs will be lit while programming.

1. Press the DELICATES/BULKY (Λ) or the COLD (V) keypad to scroll through the programmable Special Vend 1 options until **SP 1 12** appears in the display.
2. When **SP 1 12** appears in the display, press the START (enter) keypad. The current value will appear in the display.

**NOTE: To go back to the current programmable Special Vend 1 option without changing the value, press the WARM (<) keypad.**

3. Press the DELICATES/BULKY (Λ) or the COLD (V) keypad to increase or decrease the value of the active digit and the START keypad to enter the value of the digit and advance to the next digit.
4. Press the START (enter) keypad when the correct value appears in the display. The new value is saved and the next option will appear in the display.

### How to Program Special Vend 1 Vend Price 3

#### SP 1 13

This option allows the owner to set the vend price for a NORMAL COLD wash in Special Vend 1. The corresponding LEDs will be lit while programming.

1. Press the DELICATES/BULKY (Λ) or the COLD (V) keypad to scroll through the programmable Special Vend 1 options until **SP 1 13** appears in the display.
2. When **SP 1 13** appears in the display, press the START (enter) keypad. The current value will appear in the display.

**NOTE: To go back to the current programmable Special Vend 1 option without changing the value, press the WARM (<) keypad.**

3. Press the DELICATES/BULKY (Λ) or the COLD (V) keypad to increase or decrease the value of the active digit and the START keypad to enter the value of the digit and advance to the next digit.

4. Press the START (enter) keypad when the correct value appears in the display. The new value is saved and the next option will appear in the display.

### How to Program Special Vend 1 Vend Price 4

#### SP 1 14

This option allows the owner to set the vend price for a PERM PRESS HOT wash in Special Vend 1. The corresponding LEDs will be lit while programming.

1. Press the DELICATES/BULKY (Λ) or the COLD (V) keypad to scroll through the programmable Special Vend 1 options until **SP 1 14** appears in the display.
2. When **SP 1 14** appears in the display, press the START (enter) keypad. The current value will appear in the display.

**NOTE: To go back to the current programmable Special Vend 1 option without changing the value, press the WARM (<) keypad.**

3. Press the DELICATES/BULKY (Λ) or the COLD (V) keypad to increase or decrease the value of the active digit and the START keypad to enter the value of the digit and advance to the next digit.
4. Press the START (enter) keypad when the correct value appears in the display. The new value is saved and the next option will appear in the display.

### How to Program Special Vend 1 Vend Price 5

#### SP 1 15

This option allows the owner to set the vend price for a PERM PRESS WARM wash in Special Vend 1. The corresponding LEDs will be lit while programming.

1. Press the DELICATES/BULKY (Λ) or the COLD (V) keypad to scroll through the programmable Special Vend 1 options until **SP 1 15** appears in the display.
2. When **SP 1 15** appears in the display, press the START (enter) keypad. The current value will appear in the display.

**NOTE: To go back to the current programmable Special Vend 1 option without changing the value, press the WARM (<) keypad.**

3. Press the DELICATES/BULKY (Λ) or the COLD (V) keypad to increase or decrease the value of the active digit and the START keypad to enter the value of the digit and advance to the next digit.
4. Press the START (enter) keypad when the correct value appears in the display. The new value is saved and the next option will appear in the display.

### How to Program Special Vend 1 Vend Price 6

#### SP 1 16

This option allows the owner to set the vend price for a PERM PRESS COLD wash in Special Vend 1. The corresponding LEDs will be lit while programming.

1. Press the DELICATES/BULKY (Λ) or the COLD (V) keypad to scroll through the programmable Special Vend 1 options until **SP 1 15** appears in the display.
2. When **SP 1 15** appears in the display, press the START (enter) keypad. The current value will appear in the display.

**NOTE: To go back to the current programmable Special Vend 1 option without changing the value, press the WARM (<) keypad.**

3. Press the DELICATES/BULKY (Λ) or the COLD (V) keypad to increase or decrease the value of the active digit and the START keypad to enter the value of the digit and advance to the next digit.
4. Press the START (enter) keypad when the correct value appears in the display. The new value is saved and the next option will appear in the display.

### How to Program Special Vend 1 Vend Price 7

#### SP 1 17

This option allows the owner to set the vend price for a DELICATES/BULKY HOT wash in Special Vend 1. The corresponding LEDs will be lit while programming.

1. Press the DELICATES/BULKY (Λ) or the COLD (V) keypad to scroll through the programmable Special Vend 1 options until **SP 1 17** appears in the display.
2. When **SP 1 17** appears in the display, press the START (enter) keypad. The current value will appear in the display.

**NOTE: To go back to the current programmable Special Vend 1 option without changing the value, press the WARM (<) keypad.**

3. Press the DELICATES/BULKY (Λ) or the COLD (V) keypad to increase or decrease the value of the active digit and the START keypad to enter the value of the digit and advance to the next digit.
4. Press the START (enter) keypad with the last active digit. The next Special Vend 1 option, **SP 1 18**, will appear in the display.

### How to Program Special Vend 1 Vend Price 8

#### SP 1 18

This option allows the owner to set the vend price for a DELICATES/BULKY WARM wash in Special Vend 1. The corresponding LEDs will be lit while programming.

1. Press the DELICATES/BULKY (Λ) or the COLD (V) keypad to scroll through the programmable Special Vend 1 options until **SP 1 18** appears in the display.
2. When **SP 1 18** appears in the display, press the START (enter) keypad. The current value will appear in the display.

**NOTE: To go back to the current programmable Special Vend 1 option without changing the value, press the WARM (<) keypad.**

3. Press the DELICATES/BULKY (Λ) or the COLD (V) keypad to increase or decrease the value of the active digit and the

START keypad to enter the value of the digit and advance to the next digit.

4. Press the START (enter) keypad with the last active digit. The next Special Vend 1 option, **SP 1 19**, will appear in the display.

### How to Program Special Vend 1 Vend Price 9

#### SP 1 19

This option allows the owner to set the vend price for a DELICATES/BULKY COLD wash in Special Vend 1. The corresponding LEDs will be lit while programming.

1. Press the DELICATES/BULKY (Λ) or the COLD (V) keypad to scroll through the programmable Special Vend 1 options until **SP 1 19** appears in the display.
2. When **SP 1 19** appears in the display, press the START (enter) keypad. The current value will appear in the display.

**NOTE: To go back to the current programmable Special Vend 1 option without changing the value, press the WARM (<) keypad.**

3. Press the DELICATES/BULKY (Λ) or the COLD (V) keypad to increase or decrease the value of the active digit and the START keypad to enter the value of the digit and advance to the next digit.
4. Press the START (enter) keypad with the last active digit. The next Special Vend 1 option, **SP 1 20**, will appear in the display.

### How to Program Special Vend 1 Wash Status Agitate Steps Added Minutes

#### SP 1 20

This option allows the owner to add time to any agitate steps that have their status set to Wash in Special Vend 1.

1. Press the DELICATES/BULKY (Λ) or the COLD (V) keypad to scroll through the programmable Special Vend 1 options until **SP 1 20** appears in the display.
2. When **SP 1 20** appears in the display, press the START (enter) keypad. The current value will appear in the display.

**NOTE: To go back to the current programmable Special Vend 1 option without changing the value, press the WARM (<) keypad.**

3. Press the DELICATES/BULKY (Λ) or the COLD (V) keypad to increase or decrease the number of minutes displayed to the desired number of added minutes.
4. Press the START (enter) keypad when the correct value appears in the display. The new value is saved and the next option will appear in the display.

### How to Program Special Vend 1 Wash Status Agitate Steps Subtracted Minutes

#### SP 1 21

This option allows the owner to subtract time from any agitate steps that have their status set to Wash in Special Vend 1.

1. Press the DELICATES/BULKY (Λ) or the COLD (V) keypad to scroll through the programmable Special Vend 1 options until **SP I 21** appears in the display.
2. When **SP I 21** appears in the display, press the START (enter) keypad. The current value will appear in the display.  
**NOTE: To go back to the current programmable Special Vend 1 option without changing the value, press the WARM (<) keypad.**
3. Press the DELICATES/BULKY (Λ) or the COLD (V) keypad to increase or decrease the value of the active digit and the START keypad to enter the value of the digit and advance to the next digit.
4. Press the START (enter) keypad when the correct value appears in the display. The new value is saved and the next option will appear in the display.

### How to Program Special Vend 1 Cycle Modifier Default Value **SP I 22**

This option allows the owner to set the default cycle modifier that should be selected any time that Ready Mode is entered.

0 = Modifier LIGHT, 1 = Modifier MEDIUM, 2 = Modifier HEAVY.

1. Press the DELICATES/BULKY (Λ) or the COLD (V) keypad to scroll through the programmable Special Vend 1 options until **SP I 22** appears in the display.
2. When **SP I 22** appears in the display, press the START (enter) keypad. The current value will appear in the display.  
**NOTE: To go back to the current programmable Special Vend 1 option without changing the value, press the WARM (<) keypad.**
3. Press the DELICATES/BULKY (Λ) or the COLD (V) keypad to increase or decrease the value of the active digit and the START keypad to enter the value of the digit and advance to the next digit.
4. Press the START (enter) keypad when the correct value appears in the display. The new value is saved and the next option will appear in the display.

### How to Program Special Vend 1 Cycle Modifier MEDIUM Key #1 Vend Price **SP I 23**

1. Press the DELICATES/BULKY (Λ) or the COLD (V) keypad to scroll through the programmable Special Vend 1 options until **SP I 23** appears in the display.
2. When **SP I 23** appears in the display, press the START (enter) keypad. The current value will appear in the display.  
**NOTE: To go back to the current programmable Special Vend 1 option without changing the value, press the WARM (<) keypad.**
3. Press the DELICATES/BULKY (Λ) or the COLD (V) keypad to increase or decrease the value of the active digit and the START keypad to enter the value of the digit and advance to the next digit.

4. Press the START (enter) keypad when the correct value appears in the display. The new value is saved and the next option will appear in the display.

### How to Program Special Vend 1 Cycle Modifier HEAVY Key #2 Vend Price **SP I 24**

1. Press the DELICATES/BULKY (Λ) or the COLD (V) keypad to scroll through the programmable Special Vend 1 options until **SP I 24** appears in the display.
2. When **SP I 24** appears in the display, press the START (enter) keypad. The current value will appear in the display.  
**NOTE: To go back to the current programmable Special Vend 1 option without changing the value, press the WARM (<) keypad.**
3. Press the DELICATES/BULKY (Λ) or the COLD (V) keypad to increase or decrease the value of the active digit and the START keypad to enter the value of the digit and advance to the next digit.
4. Press the START (enter) keypad when the correct value appears in the display. The new value is saved and the next option will appear in the display.

### How to Program Special Vend 1 Cycle Modifier MEDIUM Key #1 Options **SP I 25**

1. Press the DELICATES/BULKY (Λ) or the COLD (V) keypad to scroll through the programmable Special Vend 1 options until **SP I 25** appears in the display.
2. When **SP I 25** appears in the display, press the START (enter) keypad. The current value will appear in the display.  
**NOTE: To go back to the current programmable Special Vend 1 option without changing the value, press the WARM (<) keypad.**
3. Press the DELICATES/BULKY (Λ) or the COLD (V) keypad to increase or decrease the value to enable the desired options to be active when the MEDIUM keypad is active. Refer to *Table 1*.
4. Press the START (enter) keypad when the correct value appears in the display. The new value is saved and the next option will appear in the display.

### How to Program Special Vend 1 Cycle Modifier HEAVY Key #2 Options **SP I 26**

1. Press the DELICATES/BULKY (Λ) or the COLD (V) keypad to scroll through the programmable Special Vend 1 options until **SP I 26** appears in the display.
2. When **SP I 26** appears in the display, press the START (enter) keypad. The current value will appear in the display.  
**NOTE: To go back to the current programmable Special Vend 1 option without changing the value, press the WARM (<) keypad.**



3. Press the DELICATES/BULKY (Λ) or the COLD (V) keypad to increase or decrease to enable the desired options to be active when the HEAVY keypad is active. Refer to *Table 1*.
4. Press the START (enter) keypad when the correct value appears in the display. The new value is saved and the next option will appear in the display.

### How to Program Special Vend 1 Extract Speed Limit *SP1 27*

1. Press the DELICATES/BULKY (Λ) or the COLD (V) keypad to scroll through the programmable Special Vend 1 options until *SP1 27* appears in the display.
2. When *SP1 27* appears in the display, press the START (enter) keypad. The current value will appear in the display.

**NOTE: To go back to the current programmable Special Vend 1 option without changing the value, press the WARM (<) keypad.**

3. Press the DELICATES/BULKY (Λ) or the COLD (V) keypad to increase or decrease the value of the speed to be limited. Keep the speed at the highest programmable value for no limit to the spin speed.
4. Press the START (enter) keypad when the correct value appears in the display. The new value is saved and the next option will appear in the display.

### Special Vend 2 Days Enable *SP2*

This option allows the owner to enable or disable a second special vend. Special Vend 2 can be programmed using an external device or network. The owner may also turn the Special Vend 2 option on or off.

1. Control must be in Manual Mode. Refer to *How to Enter the Manual Mode*.
2. Press the DELICATES/BULKY (Λ) or the COLD (V) keypad until *Pr09* appears in the display. Press the START (enter) keypad, and *Rt5 1* will appear in the display.
3. Press the DELICATES/BULKY (Λ) or the COLD (V) keypad to scroll through the programmable options until *SP2* appears in the display.
4. When *SP2* appears in the display, press the START (enter) keypad. The current Special Vend 2 Days Enable status will appear in the display.

**ON** = Option Enabled

**OFF** = Option Disabled (factory default setting)

5. Press the DELICATES/BULKY (Λ) or the COLD (V) keypad to change the current status.
6. Press the START (enter) keypad when the correct value appears in the display. The new value is saved and the next option will appear in the display.

### Special Vend 3 Days Enable *SP3*

This option allows the owner to enable or disable third special vend. Special Vend 3 can be programmed using an external device or network. The owner may also turn the Special Vend 3 option on or off.

1. Control must be in Manual Mode. Refer to *How to Enter the Manual Mode*.
2. Press the DELICATES/BULKY (Λ) or the COLD (V) keypad until *Pr09* appears in the display. Press the START (enter) keypad, and *Rt5 1* will appear in the display.
3. Press the DELICATES/BULKY (Λ) or the COLD (V) keypad to scroll through the programmable options until *SP3* appears in the display.
4. When *SP3* appears in the display, press the START (enter) keypad. The current Special Vend 3 Days Enable status will appear in the display.

**ON** = Option Enabled

**OFF** = Option Disabled (factory default setting)

5. Press the DELICATES/BULKY (Λ) or the COLD (V) keypad to change the current status.
6. Press the START (enter) keypad when the correct value appears in the display. The new value is saved and the next option will appear in the display.

### Special Vend 4 Days Enable *SP4*

This option allows the owner to enable or disable a fourth special vend. Special Vend 4 can be programmed using an external device or network. The owner may also turn the Special Vend 4 option on or off if desired.

1. Control must be in Manual Mode. Refer to *How to Enter the Manual Mode*.
2. Press the DELICATES/BULKY (Λ) or the COLD (V) keypad until *Pr09* appears in the display. Press the START (enter) keypad, and *Rt5 1* will appear in the display.
3. Press the DELICATES/BULKY (Λ) or the COLD (V) keypad to scroll through the programmable options until *SP4* appears in the display.
4. When *SP4* appears in the display, press the START (enter) keypad. The current Special Vend 4 Days Enable status will appear in the display.

**ON** = Option Enabled

**OFF** = Option Disabled (factory default setting)

5. Press the DELICATES/BULKY (Λ) or the COLD (V) keypad to change the current status.
6. Press the START (enter) keypad when the correct value appears in the display. The new value is saved and the next option will appear in the display.

## Cycle Modifier Programming $\text{CNP-}$

This option allows the owner to program the machine to offer an added prewash, extra wash time, an added rinse, extra rinse time, a warm rinse, or any combination of the above to the customers for an added vend price. This option is used when MEDIUM or HEAVY is selected using the modifier keypad.

### How to Program Default Cycle Modifier $\text{CNP 1}$

This option allows the owner to set the Default Cycle Modifier.

- Control must be in Manual Mode. Refer to *How to Enter the Manual Mode*.
- Press the DELICATES/BULKY ( $\wedge$ ) or the COLD ( $\vee$ ) keypad until  $\text{PrOG}$  appears in the display. Press the START (enter) keypad, and  $\text{RtS 1}$  will appear in the display.
- Press the DELICATES/BULKY ( $\wedge$ ) or the DELICATES/BULKY ( $\vee$ ) keypad to scroll through the programmable options until  $\text{CNP-}$  appears in the display.
- When  $\text{CNP-}$  appears in the display, press the START (enter) keypad.
- Press the DELICATES/BULKY ( $\wedge$ ) or the COLD ( $\vee$ ) keypad to scroll through the programmable Cycle Modifier options until  $\text{CNP 1}$  appears in the display.
- When  $\text{CNP 1}$  appears in the display, press the START (enter) keypad. A number will appear in the display. This number corresponds to the current default cycle modifier. Refer to table below.

$\text{CNP 1}$	
Default Value	Cycle Modifier
0*	LIGHT
1	MEDIUM
2	HEAVY

Table 9 continues...

$\text{CNP 1}$	
Default Value	Cycle Modifier
*Factory default setting.	

Table 9

- Press the DELICATES/BULKY ( $\wedge$ ) or the COLD ( $\vee$ ) keypad to increase or decrease the current number to the desired number selected from the table.
- Press the START (enter) keypad when the correct value appears in the display. The new value is saved and the next option will appear in the display.

### How to Program Cycle Modifier MEDIUM Key #1 Options $\text{CNP 2}$

This option allows the owner to select the options that are enabled when the MEDIUM modifier keypad is active.

- Control must be in Manual Mode. Refer to *How to Enter the Manual Mode*.
- Press the DELICATES/BULKY ( $\wedge$ ) or the COLD ( $\vee$ ) keypad until  $\text{PrOG}$  appears in the display. Press the START (enter) keypad, and  $\text{RtS 1}$  will appear in the display.
- Press the DELICATES/BULKY ( $\wedge$ ) or the COLD ( $\vee$ ) keypad to scroll through the programmable options until  $\text{CNP-}$  appears in the display.
- When  $\text{CNP-}$  appears in the display, press the START (enter) keypad.
- Press the DELICATES/BULKY ( $\wedge$ ) or the COLD ( $\vee$ ) keypad to scroll through the programmable options until  $\text{CNP 2}$  appears in the display.
- When  $\text{CNP 2}$  appears in the display, press the START (enter) keypad.

**NOTE: To go back to the current programmable option without changing the value, press the WARM ( $\leftarrow$ ) keypad.**

- Press the DELICATES/BULKY ( $\wedge$ ) or the COLD ( $\vee$ ) keypad to change the configuration value. Refer to the table below for the value definitions.
- Press the START (enter) keypad when the correct value appears in the display. The new value is saved and the next option will appear in the display.

Each row contains a unique combination of the words “ON” and “OFF” that indicates if that column’s feature is turned on or off when the value is entered. Select the desired combination of features and enter the number found in the value column.

<b>Configuration Value</b>	<b>Warm Final Rinse</b>  <b>Warm Rinse over-rides fill temperature for Final Fill</b>  <b>Enables Warm Rinse for the last active Fill Step in all cycles</b>	<b>Extra Rinse Steps Agitate Time</b>  <b>Time Added to Rinse Status Fill and Agitate Steps</b>  <b>Adds additional time for all Agitate Steps with their Status set to Rinse 1</b>	<b>Extra Wash Steps Agitate Time</b>  <b>Time Added to Wash Status Fill and Agitate Steps</b>  <b>Adds additional time for all Agitate Steps with their Status set to Wash</b>	<b>Extra Rinse Modifier #2 Active Steps Enabled</b>  <b>Turns on all Cycle Steps with Active State set to <i>Mod 2</i></b>	<b>Prewash Modifier #1 Active Steps Enabled</b>  <b>Turns on all Cycle Steps with Active State set to <i>Mod 1</i></b>
0	OFF	OFF	OFF	OFF	OFF
1 *	OFF	OFF	OFF	OFF	ON
2 **	OFF	OFF	OFF	ON	OFF
3 ***	OFF	OFF	OFF	ON	ON
4	OFF	OFF	ON	OFF	OFF
5	OFF	OFF	ON	OFF	ON
6	OFF	OFF	ON	ON	OFF
7	OFF	OFF	ON	ON	ON
8	OFF	ON	OFF	OFF	OFF
9	OFF	ON	OFF	OFF	ON
10	OFF	ON	OFF	ON	OFF
11	OFF	ON	OFF	ON	ON
12	OFF	ON	ON	OFF	OFF
13	OFF	ON	ON	OFF	ON
14	OFF	ON	ON	ON	OFF
15	OFF	ON	ON	ON	ON
16	ON	OFF	OFF	OFF	OFF
17	ON	OFF	OFF	OFF	ON
18	ON	OFF	OFF	ON	OFF
19	ON	OFF	OFF	ON	ON
20	ON	OFF	ON	OFF	OFF
21	ON	OFF	ON	OFF	ON
22	ON	OFF	ON	ON	OFF
23	ON	OFF	ON	ON	ON

Table 10 continues...

Configuration Value	Warm Final Rinse  Warm Rinse over-rides fill temperature for Final Fill  Enables Warm Rinse for the last active Fill Step in all cycles	Extra Rinse Steps Agitate Time  Time Added to Rinse Status Fill and Agitate Steps  Adds additional time for all Agitate Steps with their Status set to Rinse 1	Extra Wash Steps Agitate Time  Time Added to Wash Status Fill and Agitate Steps  Adds additional time for all Agitate Steps with their Status set to Wash	Extra Rinse Modifier #2 Active Steps Enabled  Turns on all Cycle Steps with Active State set to <i>Mod 2</i>	Prewash Modifier #1 Active Steps Enabled  Turns on all Cycle Steps with Active State set to <i>Mod 1</i>
24	ON	ON	OFF	OFF	OFF
25	ON	ON	OFF	OFF	ON
26	ON	ON	OFF	ON	OFF
27	ON	ON	OFF	ON	ON
28	ON	ON	ON	OFF	OFF
29	ON	ON	ON	OFF	ON
30	ON	ON	ON	ON	OFF
31	ON	ON	ON	ON	ON
* Default for Cycle Modifier MEDIUM Key #1 Option starting Serial No. 1503031611					
** Default for Cycle Modifier MEDIUM Key #1 Option through Serial No. 1503031610					
*** Default for Cycle Modifier HEAVY Key #2 Option					

Table 10

### How to Program Cycle Modifier HEAVY Key #2 Options *ENP 3*

This option allows the owner to select the options that are enabled when the HEAVY modifier keypad is active.

- Control must be in Manual Mode. Refer to *How to Enter the Manual Mode*.
- Press the DELICATES/BULKY (Λ) or the COLD (V) keypad until *P-r-o-g* appears in the display. Press the START (enter) keypad, and *HE5 1* will appear in the display.
- Press the DELICATES/BULKY (Λ) or the COLD (V) keypad to scroll through the programmable options until *ENP-* appears in the display.
- When *ENP-* appears in the display, press the START (enter) keypad.
- Press the DELICATES/BULKY (Λ) or the COLD (V) keypad to scroll through the programmable options until *ENP 3* appears in the display.

- When *ENP 3* appears in the display, press the START (enter) keypad.

**NOTE: To go back to the current programmable option without changing the value, press the WARM (<) keypad.**

- Press the DELICATES/BULKY (Λ) or the COLD (V) keypad to change the configuration value.

Refer to *Table 10* for the value definitions.

- Press the START (enter) keypad when the correct value appears in the display. The new value is saved and the next option will appear in the display.

### How to Program Cycle Modifier MEDIUM Additional Wash Time *ENP 4*

This option allows the owner to add additional time to agitate steps that have wash selected as their status. The additional wash time option needs to be turned on for the Cycle Modifier MEDIUM Additional Wash Time to take effect.

1. Control must be in Manual Mode. Refer to *How to Enter the Manual Mode*.
2. Press the DELICATES/BULKY (Λ) or the COLD (V) keypad until **P-r-o-g** appears in the display. Press the START (enter) keypad, and **RLS 1** will appear in the display.
3. Press the DELICATES/BULKY (Λ) or the COLD (V) keypad to scroll through the programmable options until **CNP-** appears in the display.
4. When **CNP-** appears in the display, press the START (enter) keypad.
5. Press the DELICATES/BULKY (Λ) or the COLD (V) keypad to scroll through the programmable options until **CNP 4** appears in the display.
6. When **CNP 4** appears in the display, press the START (enter) keypad. A number will appear in the display corresponding to the number of minutes to be added to agitate steps that have wash selected as their status.
7. Press the DELICATES/BULKY (Λ) or the COLD (V) keypad to increase or decrease the current number minutes.
8. Press the START (enter) keypad when the correct value appears in the display. The new value is saved and the next option will appear in the display.

### How to Program Cycle Modifier MEDIUM Additional Rinse Time **CNP 5**

This option allows the owner to add additional time to agitate steps that have Rinse 1 selected as their status. The additional rinse time option needs to be turned on for the Cycle Modifier MEDIUM Additional Rinse Time to take effect.

1. Control must be in Manual Mode. Refer to *How to Enter the Manual Mode*.
2. Press the DELICATES/BULKY (Λ) or the COLD (V) keypad until **P-r-o-g** appears in the display. Press the START (enter) keypad, and **RLS 1** will appear in the display.
3. Press the DELICATES/BULKY (Λ) or the COLD (V) keypad to scroll through the programmable options until **CNP-** appears in the display.
4. When **CNP-** appears in the display, press the START (enter) keypad.
5. When **CNP 5** appears in the display, press the START (enter) keypad. A number will appear in the display corresponding to the number of minutes to be added to steps that have Rinse 1 selected as their status.
6. Press the DELICATES/BULKY (Λ) or the COLD (V) keypad to increase or decrease the current number of minutes.  
**NOTE: To go back to the current programmable option without changing the value, press the WARM (<) keypad.**
7. Press the START (enter) keypad when the correct value appears in the display. The new value is saved and the next option will appear in the display.

### How to Program Cycle Modifier HEAVY Additional Wash Time **CNP 6**

This option allows the owner to add additional time to agitate steps that have wash selected as their status. The additional wash time option needs to be turned on for the Cycle Modifier HEAVY Additional Wash Time to take effect.

1. Control must be in Manual Mode. Refer to *How to Enter the Manual Mode*.
2. Press the DELICATES/BULKY (Λ) or the COLD (V) keypad until **P-r-o-g** appears in the display. Press the START (enter) keypad, and **RLS 1** will appear in the display.
3. Press the DELICATES/BULKY (Λ) or the COLD (V) keypad to scroll through the programmable options until **CNP-** appears in the display.
4. When **CNP-** appears in the display, press the START (enter) keypad.
5. Press the DELICATES/BULKY (Λ) or the COLD (V) keypad to scroll through the programmable options until **CNP 6** appears in the display.
6. When **CNP 6** appears in the display, press the START (enter) keypad. A number will appear in the display corresponding to the number of minutes to be added to steps that have Wash selected as their status.
7. Press the DELICATES/BULKY (Λ) or the COLD (V) keypad to increase or decrease the current number of minutes.
8. Press the START (enter) keypad when the correct value appears in the display. The new value is saved and the next option will appear in the display.

### How to Program Cycle Modifier HEAVY Additional Rinse Time **CNP 7**

This option allows the owner to add additional time to agitate steps that have Rinse 1 selected as their status. The additional rinse time option needs to be turned on for the Cycle Modifier HEAVY Additional Rinse Time to take effect.

1. Control must be in Manual Mode. Refer to *How to Enter the Manual Mode*.
2. Press the DELICATES/BULKY (Λ) or the COLD (V) keypad until **P-r-o-g** appears in the display. Press the START (enter) keypad, and **RLS 1** will appear in the display.
3. Press the DELICATES/BULKY (Λ) or the COLD (V) keypad to scroll through the programmable options until **CNP-** appears in the display.
4. When **CNP-** appears in the display, press the START (enter) keypad.
5. Press the DELICATES/BULKY (Λ) or the COLD (V) keypad to scroll through the programmable options until **CNP 7** appears in the display.
6. When **CNP 7** appears in the display, press the START (enter) keypad. A number will appear in the display corresponding to

the number of minutes to be added to steps that have Rinse 1 selected as their status.

7. Press the DELICATES/BULKY (Λ) or the COLD (V) keypad to increase or decrease the current number of minutes
8. Press the START (enter) keypad when the correct value appears in the display. The new value is saved and the next option will appear in the display.

## How to Enter Cycle Programming

### CYCLE -

1. Control must be in Manual Mode. Refer to *How to Enter the Manual Mode*.
2. Press the DELICATES/BULKY (Λ) or the COLD (V) keypad until **Prog** appears in the display. Press the START (enter) keypad, and **St 1** will appear in the display.
3. Press the DELICATES/BULKY (Λ) or the COLD (V) keypad to scroll through the programmable options until **CYCLE -** appears in the display. Press the START (enter) keypad and **CYCLE 1** will appear in the display.  
**NOTE: The LED light next to the select cycle keypad will be lit to indicate which cycle is being programmed.**
4. Press the DELICATES/BULKY (Λ) or the COLD (V) keypad to scroll through the cycles to program.

5. Press the START (enter) keypad when the desired cycle appears in the display. **PCYCLed** will appear in the display if enabled. Otherwise the first cycle step will appear. Refer to *Table 11* for keypad navigation.
6. For each cycle, the Programmable Cycle Time Display can be programmed, if enabled in Global Programming Parameters (refer to *Programmable Cycle Time Display PCyCtd*). Press the START (enter) keypad to program the displayed time.
7. Press the DELICATES/BULKY (Λ) or the COLD (V) keypad until the desired value is on the display. Values range from 0 - 65,535. A value of 0 will disable Programmable Cycle Time for the selected cycle. This allows for some cycles to use a Programmable Cycle Time while others use the time calculated from the enabled steps.
8. Press the START (enter) keypad. The new value is saved and **01XXXX** appears in the display. The first two digits represent the Cycle Step number and will flash. XXXX will show the step type. The machine is able to have up to 50 custom steps programmed for each cycle. Within each step there are several programmable options. Refer to the following sections for details about each step type and its options.
9. After the last cycle step is stored, **CYCLEnd** is displayed. If 50 steps are programmed **CYCLEnd** will not be displayed. To insert a step at the end of the cycle, first go to this display and then press the NORMAL keypad.

Functionality of Keypads in Cycle Programming				
Keypad	Level 3	Level 4	Level 5	Level 6
Start (Enter)	Enters Level 4.	If on Programmable Cycle Time Display Parameter, key press saves current value and goes back to Level 3. Otherwise it loads default parameter values for the step if the step type has changed, saves the set step type into the Programmable Cycle, and enters Level 5.	Enters Level 6.	Saves current parameter value being programmed into the Programmable Cycle.
DELICATES/BULKY (Λ)	Moves to the next parameter.	If on Programmable Cycle Time Display Parameter, key press increases parameter value, otherwise moves to next Step Type.	Increases the Step Parameter.	Increases parameter value.

Table 11 continues...

<b>Functionality of Keypads in Cycle Programming</b>				
<b>Keypad</b>	<b>Level 3</b>	<b>Level 4</b>	<b>Level 5</b>	<b>Level 6</b>
COLD (v)	Moves to the previous parameter.	If on Programmable Cycle Time Display Parameter, key press decreases parameter value, otherwise moves to previous Step Type.	Decreases the Step Parameter.	Decreases parameter value.
WARM (<)	Saves Current Cycle Table being modified into control's memory and goes back to Level 2.	Goes to Level 3. Does not save the current step type that is selected.	Goes to Level 3, not Level 4	Goes to Level 5, Does not save current parameter value.
NORMAL (Insert)	Inserts a Cycle Step with step type defaults at current location and shifts steps at current step number to Step 49 down. Step 50 is deleted if it exists.	Invalid	Invalid	Invalid
HOT (Delete)	Deletes Cycle Step at current location and shifts step at current step number down to Step 50 up a location. Step 50 is reset as an invalid step.	Invalid	Invalid	Invalid

Table 11

### Programming the Fill Step Type

The Fill Step Type allows the owner to program the fill steps of a cycle. After selecting the desired Cycle Step number and pressing

START (enter), **HHF ,LL** will appear in the display. Press the DELICATES/BULKY (Λ) or the COLD (V) keypad to scroll through the options and START (enter) to select a value.

Step Type	Display A	Display B	Values	Description
<b>HHF ,LL</b>				Fill Step Type ( <b>HH</b> is step number, step type is flashing)
	<b>En d IS</b>	<b>HHF ,01</b>	<b>EnAbLE, d ISAbL, dMod 1, dMod 2</b>	Step Enable/Disable Choosing <b>dMod 1</b> and <b>dMod 2</b> will enable the step if the cycle modifier is chosen and set to be enabled in <i>Cycle Modifier Programming CNP-</i> .
	<b>StAtUS</b>	<b>HHF ,02</b>	<b>PrEUSH, URSH, r inSE 1, r inSE2, r inSE3, r inSE4, SP in</b>	Status LED: The corresponding LED on the control will be lit during this step.
	<b>MinUTE</b>	<b>HHF ,03</b>	0-255	Step Minutes: If Programmed Cycle Time Display is enabled and set to a value greater than zero, it will override this time.
	<b>SECOnd</b>	<b>HHF ,04</b>	0-59	Step Seconds: If Programmed Cycle Time Display is enabled and set to a value greater than zero, it will override this time.
	<b>LEvEL</b>	<b>HHF ,05</b>	<b>LoU, Med, H IGH</b> 1-30	Water Level: Low, Medium and High levels are globally programmed. 1-30 is 5.4 to 8.3 inches.
	<b>u tEMP</b>	<b>HHF ,06</b>	<b>COld, URn, HOt, ECF</b>	Water Valve Temperature; <b>ECF</b> = Temperature Controlled Fill on models with heater
	<b>FLUSH</b>	<b>HHF ,08</b>	<b>no, YES</b>	Flush Out: Evacuates water at the beginning of the step for the globally programmed time which helps clean out the tub and prevent the excess dirty water from mixing with the fresh water.
	<b>rotAtE</b>	<b>HHF ,09</b>	3-255	Motor On Time (seconds)
	<b>PAUSE</b>	<b>HHF ,10</b>	3-255	Motor Off Time (seconds)
	<b>SPEED</b>	<b>HHF ,11</b>	<b>no rot, LoU A9, rE9 A9</b> 10 - 50 RPMs (0.03 - 0.77 G Force)	Rotation Speed
	<b>rEvErS</b>	<b>HHF ,12</b>	<b>rEv on, no rEv</b>	Reversing

Table 12



## Programming the Supply Step Type

The Supply Step Type allows the owner to program the addition of chemicals to the load. After selecting the desired Cycle Step

number and pressing START (enter), **HHSUPP** will appear in the display. Press the DELICATES/BULKY (Λ) or the COLD (V) keypad to scroll through the options and START (enter) to select a value.

Step Type	Display A	Display B	Values	Description
<b>HHSUPP</b>				Supply Step Type ( <b>HH</b> is step number, step type is flashing)
	<b>En d i S</b>	<b>HHSU01</b>	<b>EnAbLE, d iSAbL, dMod 1, dMod 2</b>	Step Enable/Disable Choosing <b>dMod 1</b> and <b>dMod 2</b> will enable the step if the cycle modifier is chosen and set to be enabled in <i>Cycle Modifier Programming CNP-</i> .
	<b>StAtEUS</b>	<b>HHSU02</b>	<b>PrEiSH, WASH, r iNSE 1, r iNSE2, r iNSE3, r iNSE4, SP in</b>	Status LED: The corresponding LED on the control will be lit during this step.
	<b>M inUTE</b>	<b>HHSU03</b>	0-255	Step Minutes: If Programmed Cycle Time Display is enabled and set to a value greater than zero, it will override this time.
	<b>SECond</b>	<b>HHSU04</b>	0-59	Step Seconds: If Programmed Cycle Time Display is enabled and set to a value greater than zero, it will override this time.
	<b>W tEMP</b>	<b>HHSU05</b>	<b>CoLd, WArM, Hot</b>	Water Valve Temperature. This parameter is only used when an Independent Supply Step.
	<b>dELAY</b>	<b>HHSU06</b>	0-255	Delay time allows water to start flowing before chemicals (internal or external) are introduced to the machine.
	<b>SHUtoF</b>	<b>HHSU07</b>	<b>t iNE, LEvEL</b>	Shutoff for external supplies. It can be set for the programmed Supply Time or when the last target water level has been reached.
	<b>dEtBLH</b>	<b>HHSU13</b>	<b>oFF, on</b>	Detergent and Bleach
	<b>SoFtEr</b>	<b>HHSU14</b>	<b>oFF, on</b>	Softener When programmed on in a cycle, the compartment will be flushed by turning on for 10 seconds at the programmed start time, then off for 15 seconds, then on for the remaining programmed time to allow for better flushing of the compartment.
	<b>oUtP 1</b>	<b>HHSU19</b>	<b>oFF, on</b>	External Output #1
	<b>oUtP 2</b>	<b>HHSU20</b>	<b>oFF, on</b>	External Output #2
	<b>oUtP 3</b>	<b>HHSU21</b>	<b>oFF, on</b>	External Output #3

Table 13 continues...

Step Type	Display A	Display B	Values	Description
	<i>oUtp 4</i>	<i>HH5U22</i>	<i>oFF, on</i>	External Output #4

Table 13

Supply Steps are unique in that they can either be run independently or be tied to a Fill Step. The following tables are examples of when the Supply step will be active. All steps below are shown as enabled, other disabled steps may exist in between shown steps.

When Supply Step is active with a Fill Step, Supply Step time is not counted towards total cycle time. Supply steps act as their own step any time an enabled Fill Step does not directly precede the enabled Supply Steps.

Steps	When active
Step 1 Fill Step	
Step 2 Supply Step	Active with Step 1
Step 3 Supply Step	Active with Step 1
Step 4 Agitate Step	
Step 1 Fill Step	
Step 2 Agitate Step	
Step 3 Supply Step	Acts as own step
Step 4 Supply Step	Acts as own step
Step 5 Extract Step	

Table 14

Steps	When active
Step 1 Supply Step	Acts as own step
Step 2 Fill Step	
Step 3 Supply Step	Active with Step 2
Step 4 Agitate Step	
Step 1 Fill Step	
Step 2 Agitate Step	
Step 3 Supply Step	Acts as own step
Step 4 Fill Step	
Step 5 Supply Step	Active with Step 4

Table 15

## Programming the Agitate Step Type

The Agitate Step Type allows the owner to program the agitate steps of a cycle. After selecting the desired Cycle Step number

and pressing START (enter), **HH99** will appear in the display. Press the DELICATES/BULKY (Λ) or the COLD (V) keypad to scroll through the options and START (enter) to select a value.

Step Type	Display A	Display B	Values	Description
<b>HH99</b>				Agitate Step Type ( <b>HH</b> is step number, step type is flashing)
	<i>En d IS</i>	<b>HH9901</b>	<i>EnAbLE, d ISAbL, dMod 1, dMod 2</i>	Step Enable/Disable Choosing <i>dMod 1</i> and <i>dMod 2</i> will enable the step if the cycle modifier is chosen and set to be enabled in <i>Cycle Modifier Programming CNP</i> .
	<i>StAtUS</i>	<b>HH9902</b>	<i>PrEUSH, WASH, r inSE 1, r inSE 2, r inSE 3, r inSE 4, SP in</i>	Status LED: The corresponding LED on the control will be lit during this step.
	<i>MinUTE</i>	<b>HH9903</b>	0-255	Step Minutes: If Programmed Cycle Time Display is enabled and set to a value greater than zero, it will override this time.
	<i>SECOnd</i>	<b>HH9904</b>	0-59	Step Seconds: If Programmed Cycle Time Display is enabled and set to a value greater than zero, it will override this time.
	<i>rotAtE</i>	<b>HH9907</b>	3-255	Motor On Time (seconds)
	<i>PAUSE</i>	<b>HH9908</b>	3-255	Motor Off Time (seconds)
	<i>SPEED</i>	<b>HH9909</b>	<i>no rot, LoU AG, rEG AG</i> 10 - 50 RPMs (0.03 - 0.77 G Force)	Rotation Speed
	<i>rEvErS</i>	<b>HH9910</b>	<i>rEuoN, no rEuo</i>	Reversing
	<i>drA in 1</i>	<b>HH9911</b>	<i>oFF, oN</i>	Drain
	<i>rEF iLL</i>	<b>HH9913</b>	<i>oFF, oN</i>	Refill: If the water level drops while in the step, water will be added until the last set water level set by the last run fill step is reached.
	<i>oUtP 1</i>	<b>HH9915</b>	<i>oFF, oN</i>	External Output #1
	<i>oUtP 2</i>	<b>HH9916</b>	<i>oFF, oN</i>	External Output #2
	<i>oUtP 3</i>	<b>HH9917</b>	<i>oFF, oN</i>	External Output #3
	<i>oUtP 4</i>	<b>HH9918</b>	<i>oFF, oN</i>	External Output #4

Table 16

### Programming the Soak Step Type

The Soak Step Type allows the owner to program a soak step in a cycle. The Soak Step Type is identical to the Agitate Step Type except that it allows hours and minutes to be programmed rather

than minutes and seconds. After selecting the desired Cycle Step number and pressing START (enter), **HHSoFF** will appear in the display. Press the DELICATES/BULKY (Λ) or the COLD (V) keypad to scroll through the options and START (enter) to select a value.

Step Type	Display A	Display B	Values	Description
<b>HHSoFF</b>				Soak Step Type ( <i>HH</i> is step number, step type is flashing)
	<i>En d i S</i>	<b>HHSo01</b>	<i>EnRbLE, d iSRbL, dMod 1, dMod 2</i>	Step Enable/Disable Choosing <i>dMod 1</i> and <i>dMod 2</i> will enable the step if the cycle modifier is chosen and set to be enabled in <i>Cycle Modifier Programming CNP-</i> .
	<i>StAtUS</i>	<b>HHSo02</b>	<i>PrE' iSH, ' iASH, r i nSE 1, r i nSE2, r i nSE3, r i nSE4, SP i n</i>	Status LED: The corresponding LED on the control will be lit during this step.
	<i>HoUr S</i>	<b>HHSo03</b>	0-255	Step Hours: If Programmed Cycle Time Display is enabled and set to a value greater than zero, it will override this time.
	<i>MinUTE</i>	<b>HHSo04</b>	0-59	Step Minutes: If Programmed Cycle Time Display is enabled and set to a value greater than zero, it will override this time.
	<i>rotAtE</i>	<b>HHSo07</b>	3-255	Motor On Time (seconds)
	<i>PAUSE</i>	<b>HHSo08</b>	3-255	Motor Off Time (seconds)
	<i>SPEED</i>	<b>HHSo09</b>	<i>no rot, Lo' i R9, rE9 R9</i> 10 - 50 RPMs (0.03 - 0.77 G Force)	Rotation Speed
	<i>rEuErS</i>	<b>HHSo10</b>	<i>rEu on, no rEu</i>	Reversing
	<i>drR in l</i>	<b>HHSo11</b>	<i>oFF, on</i>	Drain
	<i>rEF iLL</i>	<b>HHSo13</b>	<i>oFF, on</i>	Refill: If the water level drops while in the step, water will be added until the last set water level set by the last run fill step is reached.
	<i>oUtP 1</i>	<b>HHSo15</b>	<i>oFF, on</i>	External Output #1
	<i>oUtP 2</i>	<b>HHSo16</b>	<i>oFF, on</i>	External Output #2
	<i>oUtP 3</i>	<b>HHSo17</b>	<i>oFF, on</i>	External Output #3
	<i>oUtP 4</i>	<b>HHSo18</b>	<i>oFF, on</i>	External Output #4

Table 17

### Programming the Drain Step Type

The Drain Step Type allows the owner to program the drain steps of a cycle. After selecting the desired Cycle Step number and

pressing START (enter), *HHdr-R*, will appear in the display. Press the DELICATES/BULKY (Λ) or the COLD (V) keypad to scroll through the options and START (enter) to select a value.

Step Type	Display A	Display B	Values	Description
<i>HHdr-R</i>				Drain Step Type ( <i>HH</i> is step number, step type is flashing)
	<i>En d IS</i>	<i>HHdr01</i>	<i>EnAbLE, d ISAbL, dMod 1, dMod 2</i>	Step Enable/Disable Choosing <i>dMod 1</i> and <i>dMod 2</i> will enable the step if the cycle modifier is chosen and set to be enabled in <i>Cycle Modifier Programming CNP-</i> .
	<i>StAtUS</i>	<i>HHdr02</i>	<i>PrE!!SH, !!ASH, r inSE 1, r inSE2, r inSE3, r inSE4, SP in</i>	Status LED: The corresponding LED on the control will be lit during this step.
	<i>rotAtE</i>	<i>HHdr06</i>	3-255	Motor On Time (seconds)
	<i>PAUSE</i>	<i>HHdr07</i>	3-255	Motor Off Time (seconds)
	<i>SPEEd</i>	<i>HHdr08</i>	<i>no rot, Lo!! R9, rE9 R9, d IStrn</i> 15 - 90 RPMs (0.06 - 2.48 G Force)	Rotation Speed
	<i>rEuErS</i>	<i>HHdr09</i>	<i>rEu on, no rEu</i>	Reversing
	<i>oUtP 1</i>	<i>HHdr 10</i>	<i>oFF, on</i>	External Output #1
	<i>oUtP 2</i>	<i>HHdr 11</i>	<i>oFF, on</i>	External Output #2
	<i>oUtP 3</i>	<i>HHdr 12</i>	<i>oFF, on</i>	External Output #3
	<i>oUtP 4</i>	<i>HHdr 13</i>	<i>oFF, on</i>	External Output #4

Table 18

### Programming the Extract Drain (Spin) Step Type

The Extract Drain (Spin) Step Type allows the owner to program the extract drain (spin) steps of a cycle. After selecting the de-

sired Cycle Step number and pressing START (enter), *HHSP in* will appear in the display. Press the DELICATES/BULKY (Λ) or the COLD (V) keypad to scroll through the options and START (enter) to select a value.

Step Type	Display A	Display B	Values	Description
<i>HHSP in</i>				Spin Step Type ( <i>HH</i> is step number, step type is flashing)
	<i>En d i S</i>	<i>HHSP01</i>	<i>EnAbLE, d iSAbL, dMod 1, dMod 2</i>	Step Enable/Disable Choosing <i>dMod 1</i> and <i>dMod 2</i> will enable the step if the cycle modifier is chosen and set to be enabled in <i>Cycle Modifier Programming CNP-</i> .
	<i>StAtUS</i>	<i>HHSP02</i>	<i>PrEiSH, iRSH, r inSE 1, r inSE2, r inSE3, r inSE4, SP in</i>	Status LED: The corresponding LED on the control will be lit during this step.
	<i>MinUTE</i>	<i>HHSP03</i>	0-9	Step Minutes: If Programmed Cycle Time Display is enabled and set to a value greater than zero, it will override this time.
	<i>SECOnd</i>	<i>HHSP04</i>	0-59	Step Seconds: If Programmed Cycle Time Display is enabled and set to a value greater than zero, it will override this time.
	<i>SPEED</i>	<i>HHSP08</i>	<i>uE Lo", Lo", nEd, HiGH, uE H i, UL H i</i> 350-1200 RPMs (37.40-439.70 G Force)	Spin Speed
	<i>oUtP 1</i>	<i>HHSP09</i>	<i>oFF, on</i>	External Output #1
	<i>oUtP 2</i>	<i>HHSP 10</i>	<i>oFF, on</i>	External Output #2
	<i>oUtP 3</i>	<i>HHSP 11</i>	<i>oFF, on</i>	External Output #3
	<i>oUtP 4</i>	<i>HHSP 12</i>	<i>oFF, on</i>	External Output #4

Table 19

High spins will extract soap and water out of the load but can also produce suds that are harder to eliminate. For this reason all spin steps consist of a step ramped spin to reduce suds generation.

The overall Extract Speed reached is dependent on the Step Time. The Step Time accounts for Drain Time, Balance Measurement Time and Spin Time. If enough time isn't given to reach a programmed speed, the step will advance without reaching the set speed. If a speed limit is set lower than 1200 RPMs, once the machine reaches the speed limit, it will finish out the remaining time at that speed. The programmed time will also include the ramp down time with an estimated ramp down rate of 24 RPMs/second. For example, if spinning at a rate of 600 RPMs, the ma-

chine will start ramping down when 25 seconds remain in the current step.

It is recommended not to reduce spin times within the default cycles. Better machine performance is achieved with the default spin times.

### Programming the Audio Step Type

The Audio Step Type is used to alert the user with an audio pattern for a programmed duration when the step is entered. After

selecting the desired Cycle Step number and pressing START (enter), **HHAUD** will appear in the display. Press the DELICATES/BULKY (Λ) or the COLD (V) keypad to scroll through the options and START (enter) to select a value.

Step Type	Display A	Display B	Values	Description
<b>HHAUD</b>				Audio Step Type ( <b>HH</b> is step number, step type is flashing)
	<b>En d IS</b>	<b>HHAUD 1</b>	<b>EnAbLE, d ISAbL, dMod 1, dMod 2</b>	Step Enable/Disable Choosing <b>dMod 1</b> and <b>dMod 2</b> will enable the step if the cycle modifier is chosen and set to be enabled in <i>Cycle Modifier Programming CNP</i> .
	<b>StAtUS</b>	<b>HHAUD2</b>	<b>PrESt, WASH, r inSE 1, r inSE2, r inSE3, r inSE4, SP in</b>	Status LED: The corresponding LED on the control will be lit during this step.
	<b>MinUTE</b>	<b>HHAUD3</b>	0-2	Step Minutes
	<b>SECOnd</b>	<b>HHAUD4</b>	0-59	Step Seconds
	<b>AUd ioP</b>	<b>HHAUD5</b>	1-20	Audio Pattern
	<b>oUtP 1</b>	<b>HHAUD6</b>	<b>oFF, on</b>	External Output #1
	<b>oUtP 2</b>	<b>HHAUD7</b>	<b>oFF, on</b>	External Output #2
	<b>oUtP 3</b>	<b>HHAUD8</b>	<b>oFF, on</b>	External Output #3
	<b>oUtP 4</b>	<b>HHAUD9</b>	<b>oFF, on</b>	External Output #4

Table 20

### Programming the Hold Step Type

The Hold Step Type allows the owner to pause a cycle at a specific type to allow user interaction with the cycle, generally to add a

chemical. After selecting the desired Cycle Step number and pressing START (enter), **HHHoLd** will appear in the display. Press the DELICATES/BULKY (Λ) or the COLD (V) keypad to scroll through the options and START (enter) to select a value.

Step Type	Display A	Display B	Values	Description
<b>HHHoLd</b>				Hold Step Type ( <b>HH</b> is step number, step type is flashing)
	<b>En d iS</b>	<b>HHHo01</b>	<b>EnAbLE, d iSAbL, dMod 1, dMod 2</b>	Step Enable/Disable Choosing <b>dMod 1</b> and <b>dMod 2</b> will enable the step if the cycle modifier is chosen and set to be enabled in <i>Cycle Modifier Programming CNP-</i> .
	<b>StAtUS</b>	<b>HHHo02</b>	<b>PrEiSH, iRASH, r inSE 1, r inSE2, r inSE3, r inSE4, SP in</b>	Status LED: The corresponding LED on the control will be lit during this step.
	<b>MinUTE</b>	<b>HHHo03</b>	0-2	Step Minutes: If Programmed Cycle Time Display is enabled and set to a value greater than zero, it will override this time.
	<b>SECOnd</b>	<b>HHHo04</b>	0-59	Step Seconds: If Programmed Cycle Time Display is enabled and set to a value greater than zero, it will override this time.
	<b>AudioP</b>	<b>HHHo05</b>	0-20	Audio Pattern: The audio will stop once a key is pressed or the door is opened.
	<b>MESSAG</b>	<b>HHHo06</b>	<b>LoAd, CHEP, SoAP, bLEACH, SoFtEr, SoUr, StArCH, CUStN 1, CUStN2</b>	Display Message
	<b>StArLkP</b>	<b>HHHo07</b>	<b>StRtCY, UnLoCH</b>	Door Lock State
	<b>RUrESN</b>	<b>HHHo08</b>	0-255	Automatic Resume Minutes: Cycle will resume automatically after the programmed time only if the step was programmed to have the door remain locked.
	<b>oUtP 1</b>	<b>HHHo 12</b>	<b>oFF, on</b>	External Output #1
	<b>oUtP 2</b>	<b>HHHo 13</b>	<b>oFF, on</b>	External Output #2
	<b>oUtP 3</b>	<b>HHHo 14</b>	<b>oFF, on</b>	External Output #3
	<b>oUtP 4</b>	<b>HHHo 15</b>	<b>oFF, on</b>	External Output #4

Table 21

While in the Hold Step, a message is used to indicate what interaction the machine is waiting for. The Hold step can be programmed to either hold water and keep the door locked or to evacuate water and unlock the door. In both cases a Start key press will allow the cycle to resume.

This step may be used to allow the machine to be rinsed out before adding the next load. An additional vend could be charged by having a Modifier Key programmed to enable steps to perform this functionality by setting the steps as Mod 1 or Mod 2. Refer to *Cycle Modifier Programming CNP-*.



## Hold Step Custom Messages *ⓁⓃⓔⓢⓢ-*

This option allows the owner to program the machine to display a custom hold step message when a hold step is programmed.

1. Control must be in Manual Mode. Refer to *How to Enter the Manual Mode*.
2. Press the DELICATES/BULKY (Λ) or the COLD (V) keypad until *Prøø* appears in the display. Press the START (enter) keypad, and *Ⓜⓔⓢ 1* will appear in the display.
3. Press the DELICATES/BULKY (Λ) or the COLD (V) keypad to scroll through the programmable options until *ⓁⓃⓔⓢⓢ-* appears in the display.
4. When *ⓁⓃⓔⓢⓢ-* appears in the display, press the START (enter) keypad. There are two programmable Hold Step Custom Message options.

Display	Hold Step Custom Message Options
<i>ⓁⓃⓔⓢⓢ1</i>	Custom Message #1
<i>ⓁⓃⓔⓢⓢ2</i>	Custom Message #2

Table 22

5. Press the DELICATES/BULKY (Λ) or the COLD (V) keypad to change the current option.
6. Press the START (enter) keypad to change the first of six programmable characters.

**NOTE: To go back to the current programmable option without changing the value, press the WARM (<) keypad.**

7. Press the DELICATES/BULKY (Λ) or the COLD (V) keypad to change the active character and the START (enter) keypad to enter the value of the character and advance to the next character.
8. Press the START (enter) keypad when the correct value appears in the display. The new value is saved and the next option will appear in the display.

## Programmable Cycle Time Display

### *ⓅⓄⓎⓄⓔ*

This option allows the owner to program the machine to display a chosen cycle time in minutes instead of the calculated cycle time.

The cycle time display will not pause for fills. The display will switch to *01* if the end of the cycle is reached before the time display reaches *01*. If the time displayed reaches *01* before the end of the cycle, the display will pause at *01* until the cycle ends.

In order to use this option, the owner must set the programmable cycle time in a cycle to a value greater than 0. Refer to *How to Enter Cycle Programming CyCLE-*.

1. Control must be in Manual Mode. Refer to *How to Enter the Manual Mode*.
2. Press the DELICATES/BULKY (Λ) or the COLD (V) keypad until *Prøø* appears in the display. Press the START (enter) keypad, and *Ⓜⓔⓢ 1* will appear in the display.
3. Press the DELICATES/BULKY (Λ) or the COLD (V) keypad to scroll through the programmable options until *ⓅⓄⓎⓄⓔ* appears in the display.
4. When *ⓅⓄⓎⓄⓔ* appears in the display, press the START (enter) keypad. The current Cycle Time Display value will appear in the display.

*oN* = Cycle time displayed as programmed

*oFF* = Calculated remaining cycle time is displayed (factory default setting)

5. Press the DELICATES/BULKY (Λ) or the COLD (V) keypad to change the current value.
6. Press the START (enter) keypad when the correct value appears in the display. The new value is saved and the next option will appear in the display.

## No Cycle Time Display *ⓃⓄⓎⓄⓔ*

This option allows the owner to program the machine to display no cycle time instead of the cycle time being displayed, a single dashed line will move horizontally across the display for the entire cycle.

1. Control must be in Manual Mode. Refer to *How to Enter the Manual Mode*.
2. Press the DELICATES/BULKY (Λ) or the COLD (V) keypad until *Prøø* appears in the display. Press the START (enter) keypad, and *Ⓜⓔⓢ 1* will appear in the display.
3. Press the DELICATES/BULKY (Λ) or the COLD (V) keypad to scroll through the programmable options until *ⓃⓄⓎⓄⓔ* appears in the display.
4. When *ⓃⓄⓎⓄⓔ* appears in the display, press the START (enter) keypad. The current No Cycle Time Display status will appear in the display.

*oN* = Option Enabled

*oFF* = Option Disabled (factory default setting)

5. Press the DELICATES/BULKY (Λ) or the COLD (V) keypad to change the current status.
6. Press the START (enter) keypad when the correct value appears in the display. The new value is saved and the next option will appear in the display.

## Number of Balance Attempts with No Loss of Time *ⓅⓂⓁ Ⓜⓔ*

This option allows the owner to program the machine's number of balance attempts with no loss of time. If the machine needs to re-balance for any reason, time will pause for additional balance attempts when this parameter is greater than 1. A value of 1 allows

for the normal allocated time. Further attempts beyond the programmed value will not pause cycle time. This may result in lower max spin speeds and time.

1. Control must be in Manual Mode. Refer to *How to Enter the Manual Mode*.
2. Press the DELICATES/BULKY (Λ) or the COLD (V) keypad until **P-r-o-g** appears in the display. Press the START (enter) keypad, and **RL5 1** will appear in the display.
3. Press the DELICATES/BULKY (Λ) or the COLD (V) keypad to scroll through the programmable options until **bAL RL** appears in the display.
4. When **bAL RL** appears in the display, press the START (enter) keypad. The current Number of Balance Attempts with no Loss of Time will appear in the display.
5. Press the DELICATES/BULKY (Λ) or the COLD (V) keypad to change the current value. The factory default setting is 3.
6. Press the START (enter) keypad when the correct value appears in the display. The new value is saved and the next option will appear in the display.

## Cycle Pause Resume **CYCPRU**

This option allows the owner to be able to pause a running cycle when the START (enter) keypad is pressed 3 times within 5 seconds during the first 3 minutes from the start of the cycle. Once the control evacuates all water in the machine, it will unlock the door. To resume the cycle, the door must be closed and then the START (enter) keypad pressed. The cycle will continue from where it left off.

1. Control must be in Manual Mode. Refer to *How to Enter the Manual Mode*.
2. Press the DELICATES/BULKY (Λ) or the COLD (V) keypad until **P-r-o-g** appears in the display. Press the START (enter) keypad, and **RL5 1** will appear in the display.
3. Press the DELICATES/BULKY (Λ) or the COLD (V) keypad to scroll through the programmable options until **CYCPRU** appears in the display.
4. When **CYCPRU** appears in the display, press the START (enter) keypad. The current Cycle Pause Resume status will appear in the display.

**on** = Option Enabled

**off** = Option Disabled (factory default setting)

5. Press the DELICATES/BULKY (Λ) or the COLD (V) keypad to change the current status.
6. Press the START (enter) keypad when the correct value appears in the display. The new value is saved and the next option will appear in the display.

## Low Power-Auto Shutdown 1 Days Enable **LPA5 1**

This option allows the owner to set Low Power/Auto Shutdown on certain day(s) of the week. Low Power and/or Auto Shutdown days/duration are programmed using an external device or network.

1. Control must be in Manual Mode. Refer to *How to Enter the Manual Mode*.
2. Press the DELICATES/BULKY (Λ) or the COLD (V) keypad until **P-r-o-g** appears in the display. Press the START (enter) keypad, and **RL5 1** will appear in the display.
3. Press the DELICATES/BULKY (Λ) or the COLD (V) keypad to scroll through the programmable options until **LPA5 1** appears in the display.
4. When **LPA5 1** appears in the display, press the START (enter) keypad. The current Low Power/Auto Shutdown 1 Days Enable status will appear in the display.

**on** = Option Enabled

**off** = Option Disabled (factory default setting)

5. Press the DELICATES/BULKY (Λ) or the COLD (V) keypad to change the current status.
6. Press the START (enter) keypad when the correct value appears in the display. The new value is saved and the next option will appear in the display.

## Low Power-Auto Shutdown 2 Days Enable **LPA5 2**

This option allows the owner to set Low Power/Auto Shutdown on certain day(s) of the week. Low Power and/or Auto Shutdown days/duration are programmed using an external device or network.

1. Control must be in Manual Mode. Refer to *How to Enter the Manual Mode*.
2. Press the DELICATES/BULKY (Λ) or the COLD (V) keypad until **P-r-o-g** appears in the display. Press the START (enter) keypad, and **RL5 1** will appear in the display.
3. Press the DELICATES/BULKY (Λ) or the COLD (V) keypad to scroll through the programmable options until **LPA5 2** appears in the display.
4. When **LPA5 2** appears in the display, press the START (enter) keypad. The current Low Power/Auto Shutdown 2 Days Enable status will appear in the display.

**on** = Option Enabled

**off** = Option Disabled (factory default setting)

5. Press the DELICATES/BULKY (Λ) or the COLD (V) keypad to change the current status.
6. Press the START (enter) keypad when the correct value appears in the display. The new value is saved and the next option will appear in the display.

## Low Power-Auto Shutdown 3 Days Enable *L P A S 3*

This option allows the owner to set Low Power/Auto Shutdown on certain day(s) of the week. Low Power and/or Auto Shutdown days/duration are programmed using an external device or network.

- Control must be in Manual Mode. Refer to *How to Enter the Manual Mode*.
- Press the DELICATES/BULKY (Λ) or the COLD (V) keypad until *P r o g* appears in the display. Press the START (enter) keypad, and *R E S T* will appear in the display.
- Press the DELICATES/BULKY (Λ) or the COLD (V) keypad to scroll through the programmable options until *L P A S 3* appears in the display.
- When *L P A S 3* appears in the display, press the START (enter) keypad. The current Low Power/Auto Shutdown 3 Days Enable status will appear in the display.

*o n* = Option Enabled

*o f f* = Option Disabled (factory default setting)

- Press the DELICATES/BULKY (Λ) or the COLD (V) keypad to change the current status.
- Press the START (enter) keypad when the correct value appears in the display. The new value is saved and the next option will appear in the display.

## Low Power-Auto Shutdown 4 Days Enable *L P A S 4*

This option allows the owner to set Low Power/Auto Shutdown on certain day(s) of the week. Low Power and/or Auto Shutdown days/duration are programmed using an external device or network.

- Control must be in Manual Mode. Refer to *How to Enter the Manual Mode*.
- Press the DELICATES/BULKY (Λ) or the COLD (V) keypad until *P r o g* appears in the display. Press the START (enter) keypad, and *R E S T* will appear in the display.
- Press the DELICATES/BULKY (Λ) or the COLD (V) keypad to scroll through the programmable options until *L P A S 4* appears in the display.
- When *L P A S 4* appears in the display, press the START (enter) keypad. The current Low Power/Auto Shutdown 4 Days Enable status will appear in the display.

*o n* = Option Enabled

*o f f* = Option Disabled (factory default setting)

- Press the DELICATES/BULKY (Λ) or the COLD (V) keypad to change the current status.
- Press the START (enter) keypad when the correct value appears in the display. The new value is saved and the next option will appear in the display.

## Power Fail Reset *P F r 5 t*

This option allows the owner to set the amount of time the control will store active cycle information in the event of a power failure. The default setting for Power Fail Reset is OFF. If Power Fail Reset is turned OFF, the cycle will be saved.

- Control must be in Manual Mode. Refer to *How to Enter the Manual Mode*.
- Press the DELICATES/BULKY (Λ) or the COLD (V) keypad until *P r o g* appears in the display. Press the START (enter) keypad, and *R E S T* will appear in the display.
- Press the DELICATES/BULKY (Λ) or the COLD (V) keypad to scroll through the programmable options until *P F r 5 t* appears in the display.
- When *P F r 5 t* appears in the display, press the START (enter) keypad. *o f f* or a number will appear in the display. This number corresponds to the current Power Fail Reset setting.
- Press the DELICATES/BULKY (Λ) or the COLD (V) keypad to increase or decrease the current number to the desired number selected from *Table 23*.
- Press the START (enter) keypad when the correct value appears in the display. The new value is saved and the next option will appear in the display.

### How to Read Power Fail Reset Table

Use *Table 23* to set the amount of time for Power Fail Reset.

*o f f* turns the option OFF. The current cycle status will be saved. When power is restored, the cycle will begin where it was interrupted.

Setting this option from 1 - 120 will save the cycle status without power that number of minutes before the cycle is lost. A value of 0 will cause the cycle and vend to be lost any time a power failure occurs.

<i>P F r 5 t</i>	
DISPLAY TO ENTER IN STEP 6	POWER FAIL RESET TIME
<i>o f f</i> *	Turned OFF. Cycle will be saved.
0 - 120 Number in minutes	0 - 120 minutes without power before cycle is lost
* Factory default setting.	

Table 23

## IR Access *I r R E n*

This option allows the owner to enable or disable allowing the control to be communicated with by an external IR device.

1. Control must be in Manual Mode. Refer to *How to Enter the Manual Mode*.
2. Press the DELICATES/BULKY ( $\wedge$ ) or the COLD (v) keypad until **P r o g** appears in the display. Press the START (enter) keypad, and **R t S I** will appear in the display.
3. Press the DELICATES/BULKY ( $\wedge$ ) or the COLD (v) keypad to scroll through the programmable options until **I r R E n** appears in the display.
4. When **I r R E n** appears in the display, press the START (enter) keypad. The current IR Access status will appear in the display.

**o n** = Option Enabled (factory default setting)

**o F F** = Option Disabled

5. Press the DELICATES/BULKY ( $\wedge$ ) or the COLD (v) keypad to change the current status.
6. Press the START (enter) keypad when the correct value appears in the display. The new value is saved and the next option will appear in the display.

## Manual Rapid Advance *r A P d E n*

This option allows the owner to enable or disable the rapid advance feature. Refer to Rapid Advance Feature section for more information.

1. Control must be in Manual Mode. Refer to *How to Enter the Manual Mode*.
2. Press the DELICATES/BULKY ( $\wedge$ ) or the COLD (v) keypad until **P r o g** appears in the display. Press the START (enter) keypad, and **R t S I** will appear in the display.
3. Press the DELICATES/BULKY ( $\wedge$ ) or the COLD (v) keypad to scroll through the programmable options until **r A P d E n** appears in the display.
4. When **r A P d E n** appears in the display, press the START (enter) keypad. The current Manual Rapid Advance status will appear in the display.

0 = **o F F** (access requires password)

1 = **o n** (access allowed) (factory default setting)

2 = **D I S A B L E D** (access not allowed)

5. Press the DELICATES/BULKY ( $\wedge$ ) or the COLD (v) keypad to change the current status.
6. Press the START (enter) keypad when the correct value appears in the display. The new value is saved and the next option will appear in the display.

## Manual Diagnostics *d i A g E n*

This option allows the owner to enable or disable the manual diagnostics option. Refer to Testing Machine and Electronic Control Functions section for more information.

1. Control must be in Manual Mode. Refer to *How to Enter the Manual Mode*.
2. Press the DELICATES/BULKY ( $\wedge$ ) or the COLD (v) keypad until **P r o g** appears in the display. Press the START (enter) keypad, and **R t S I** will appear in the display.
3. Press the DELICATES/BULKY ( $\wedge$ ) or the COLD (v) keypad to scroll through the programmable options until **d i A g E n** appears in the display.
4. When **d i A g E n** appears in the display, press the START (enter) keypad. The current Manual Diagnostics status will appear in the display.

0 = **o F F** (access requires password)

1 = **o n** (access allowed) (factory default setting)

2 = **D I S A B L E D** (access not allowed)

5. Press the DELICATES/BULKY ( $\wedge$ ) or the COLD (v) keypad to change the current status.
6. Press the START (enter) keypad when the correct value appears in the display. The new value is saved and the next option will appear in the display.

## Factory Test *F t E n*

This option allows the owner to enable or disable access to Factory Test.

1. Control must be in Manual Mode. Refer to *How to Enter the Manual Mode*.
2. Press the DELICATES/BULKY ( $\wedge$ ) or the COLD (v) keypad until **P r o g** appears in the display. Press the START (enter) keypad, and **R t S I** will appear in the display.
3. Press the DELICATES/BULKY ( $\wedge$ ) or the COLD (v) keypad to scroll through the programmable options until **F t E n** appears in the display.
4. When **F t E n** appears in the display, press the START (enter) keypad. The current Factory Test status will appear in the display.

**o n** = Option Enabled (factory default setting)

**o F F** = Option Disabled

5. Press the DELICATES/BULKY ( $\wedge$ ) or the COLD (v) keypad to change the current status.
6. Press the START (enter) keypad when the correct value appears in the display. The new value is saved and the next option will appear in the display.

## Lucky Cycle *L U C -*

This option allows the owner to program the machine to provide a free or reduced vend cycle to users after a certain number of machine cycles have occurred.

1. Control must be in Manual Mode. Refer to *How to Enter the Manual Mode*.
2. Press the DELICATES/BULKY (Λ) or the COLD (V) keypad until **Prø9** appears in the display. Press the START (enter) keypad, and **RL5 1** will appear in the display.
3. Press the DELICATES/BULKY (Λ) or the COLD (V) keypad to scroll through the programmable options until **LUC -** appears in the display.
4. When **LUC -** appears in the display, press the START (enter) keypad. There are three programmable Lucky Cycle options. Refer to *Table 24*.

Display	Lucky Cycle Options
<b>LUC 1</b>	Lucky Cycle Day(s) of Week / Enable On/Off  Refer to <i>Table 8</i> for programming.
<b>LUC 2</b>	Lucky Cycle Number (0-255)
<b>LUC 3</b>	Lucky Cycle Display Option On/Off  ON = Free vend. Lucky cycle active after 4.25 minutes in Ready Mode.  OFF = Vend must be entered. Remaining vend is free. For example, after entering a coin the price will count down by Coin 1 value until vend is satisfied.

Table 24

**NOTE: When the Lucky Cycle conditions have been met, the display will show FREE when the Display Option is set to On.**

5. Press the DELICATES/BULKY (Λ) or the COLD (V) keypad to change the current status.
6. Press the START (enter) keypad when the correct value appears in the display. The new value is saved and the next option will appear in the display.

## Speed Units **5Un iE5**

This option allows the owner to program the speed units to be shown in RPMs or G Force for all speed related programming parameters.

1. Control must be in Manual Mode. Refer to *How to Enter the Manual Mode*.

2. Press the DELICATES/BULKY (Λ) or the COLD (V) keypad until **Prø9** appears in the display. Press the START (enter) keypad, and **RL5 1** will appear in the display.
3. Press the DELICATES/BULKY (Λ) or the COLD (V) keypad to scroll through the programmable options until **5Un iE5** appears in the display.
4. When **5Un iE5** appears in the display, press the START (enter) keypad. The current Speed Units status will appear in the display.

**rPN** = Option (factory default setting)

**9ForCE** = Option

5. Press the DELICATES/BULKY (Λ) or the COLD (V) keypad to change the current status.
6. Press the START (enter) keypad when the correct value appears in the display. The new value is saved and the next option will appear in the display.

## Programmable Close Door Display

### **PCdL**

This option allows the owner to enable or disable allowing the control to display the corresponding command to close the door along with the cycle time.

1. Control must be in Manual Mode. Refer to *How to Enter the Manual Mode*.
2. Press the DELICATES/BULKY (Λ) or the COLD (V) keypad until **Prø9** appears in the display. Press the START (enter) keypad, and **RL5 1** will appear in the display.
3. Press the DELICATES/BULKY (Λ) or the COLD (V) keypad to scroll through the programmable options until **PCdL** appears in the display.
4. When **PCdL** appears in the display, press the START (enter) keypad. The current status will appear in the display.

**on** = Option Enabled (factory default setting)

**oFF** = Option Disabled

5. Press the DELICATES/BULKY (Λ) or the COLD (V) keypad to change the current status.
6. Press the START (enter) keypad when the correct value appears in the display. The new value is saved and the next option will appear in the display.

## Programmable Push Start Display **PPSt**

This option allows the owner to enable or disable allowing the control to display the corresponding command to press the START (enter) keypad once the vend has been satisfied.

1. Control must be in Manual Mode. Refer to *How to Enter the Manual Mode*.
2. Press the DELICATES/BULKY (Λ) or the COLD (V) keypad until **Prø9** appears in the display. Press the START (enter) keypad, and **RL5 1** will appear in the display.

3. Press the DELICATES/BULKY (Λ) or the COLD (V) keypad to scroll through the programmable options until **PPSE** appears in the display.
4. When **PPSE** appears in the display, press the START (enter) keypad. The current Push Start status will appear in the display.

**ON** = Option Enabled (factory default setting)

**OFF** = Option Disabled

5. Press the DELICATES/BULKY (Λ) or the COLD (V) keypad to change the current status.
6. Press the START (enter) keypad when the correct value appears in the display. The new value is saved and the next option will appear in the display.

## Programmable Open Door Display **PodL**

This option allows the owner to enable or disable allowing the control to display the corresponding command to open the door along with the cycle time when the cycle had completed.

1. Control must be in Manual Mode. Refer to *How to Enter the Manual Mode*.
2. Press the DELICATES/BULKY (Λ) or the COLD (V) keypad until **PrOG** appears in the display. Press the START (enter) keypad, and **RLS I** will appear in the display.
3. Press the DELICATES/BULKY (Λ) or the COLD (V) keypad to scroll through the programmable options until **PodL** appears in the display.
4. When **PodL** appears in the display, press the START (enter) keypad. The current status will appear in the display.

**ON** = Option Enabled (factory default setting)

**OFF** = Option Disabled

5. Press the DELICATES/BULKY (Λ) or the COLD (V) keypad to change the current status.
6. Press the START (enter) keypad when the correct value appears in the display. The new value is saved and the next option will appear in the display.

## Vend Price Display Override **RLS do**

This option allows the owner to override the previously set vend price with a custom display that is set by the payment system. The default display is **Card** if the payment system does not modify it.

1. Control must be in Manual Mode. Refer to *How to Enter the Manual Mode*.
2. Press the DELICATES/BULKY (Λ) or the COLD (V) keypad until **PrOG** appears in the display. Press the START (enter) keypad, and **RLS I** will appear in the display.
3. Press the DELICATES/BULKY (Λ) or the COLD (V) keypad to scroll through the programmable options until “AtS do” appears in the display.

4. When **RLS do** appears in the display, press the START (enter) keypad. The current Vend Price Display Override status will appear in the display.

**ON** = Option Enabled

**OFF** = Option Disabled (factory default setting)

5. Press the DELICATES/BULKY (Λ) or the COLD (V) keypad to change the current status.
6. Press the START (enter) keypad when the correct value appears in the display. The new value is saved and the next option will appear in the display.

## OPL Parameters **oPL -**

This option allows the owner to enable or disable the OPL Parameters in which no vend price needs to be satisfied to operate the machine.

1. Control must be in Manual Mode. Refer to *How to Enter the Manual Mode*.
2. Press the DELICATES/BULKY (Λ) or the COLD (V) keypad until **PrOG** appears in the display. Press the START (enter) keypad, and **RLS I** will appear in the display.
3. Press the DELICATES/BULKY (Λ) or the COLD (V) keypad to scroll through the programmable options until **oPL -** appears in the display.
4. When **oPL -** appears in the display, press the START (enter) keypad to enter the OPL submenu.
5. Press the DELICATES/BULKY (Λ) or the COLD (V) keypad to scroll through the OPL submenu options.
6. Press the START (enter) keypad when the desired option appears in the display

### OPL Mode Enable **oPL I**

This option allows the owner to place the control in OPL Mode, in which no vend price needs to be satisfied in order to start the machine. If the control is in Start Mode, the cycle time will be displayed. Pressing the START keypad will start the machine cycle. Once a machine cycle has been started, each additional press of the START keypad will advance the cycle to the next cycle step only if Rapid Advance Programming Parameter is Enabled.

1. Control must be in Manual Mode. Refer to *How to Enter the Manual Mode*.
2. Press the DELICATES/BULKY (Λ) or the COLD (V) keypad until **PrOG** appears in the display. Press the START (enter) keypad, and **RLS I** will appear in the display.
3. Press the DELICATES/BULKY (Λ) or the COLD (V) keypad to scroll through the programmable options until **oPL -** appears in the display.
4. When **oPL -** appears in the display, press the START (enter) keypad to enter the OPL submenu.
5. Press the DELICATES/BULKY (Λ) or the COLD (V) keypad to scroll through the programmable options until **oPL I** appears in the display.

- When **oPL 1** appears in the display, press the START (enter) keypad. The current OPL status will appear in the display.

**oN** = Option Enabled

**oFF** = Option Disabled (factory default setting)

- Press the DELICATES/BULKY ( $\wedge$ ) or the COLD (v) keypad to change the current status.
- Press the START (enter) keypad when the correct value appears in the display. The new value is saved and the next option will appear in the display.

### OPL Delayed Start **oPL 2**

This option allows the owner to enable delayed start mode which can delay the cycle up to a maximum of 72 hours.

- Control must be in Manual Mode. Refer to *How to Enter the Manual Mode*.
- Press the DELICATES/BULKY ( $\wedge$ ) or the COLD (v) keypad until **Pr o 9** appears in the display. Press the START (enter) keypad, and **Rt 5 1** will appear in the display.
- Press the DELICATES/BULKY ( $\wedge$ ) or the COLD (v) keypad to scroll through the programmable options until **oPL -** appears in the display.
- When **oPL -** appears in the display, press the START (enter) keypad to enter the OPL submenu.
- Press the DELICATES/BULKY ( $\wedge$ ) or the COLD (v) keypad to scroll through the programmable options until **oPL 2** appears in the display.
- When **oPL 2** appears in the display, press the START (enter) keypad. The current OPL status will appear in the display.

**oN** = Option Enabled

**oFF** = Option Disabled (factory default setting)

- Press the DELICATES/BULKY ( $\wedge$ ) or the COLD (v) keypad to change the current status.
- Press the START (enter) keypad when the correct value appears in the display. The new value is saved and the next option will appear in the display.

### OPL Display Power Save **oPL 3**

This option allows the owner to enable the OPL Display Power Save Feature. If enabled, after 255 seconds of no user input, the control will turn off all LEDs and the display until user input occurs. The OPL Display Power Save Feature will only turn off the display if the control is in Start Mode.

- Control must be in Manual Mode. Refer to *How to Enter the Manual Mode*.
- Press the DELICATES/BULKY ( $\wedge$ ) or the COLD (v) keypad until **Pr o 9** appears in the display. Press the START (enter) keypad, and **Rt 5 1** will appear in the display.
- Press the DELICATES/BULKY ( $\wedge$ ) or the COLD (v) keypad to scroll through the programmable options until **oPL -** appears in the display.

- When **oPL -** appears in the display, press the START (enter) keypad to enter the OPL submenu.

- Press the DELICATES/BULKY ( $\wedge$ ) or the COLD (v) keypad to scroll through the programmable options until **oPL 3** appears in the display.

- When **oPL 3** appears in the display, press the START (enter) keypad. The current OPL status will appear in the display.

**oN** = Option Enabled

**oFF** = Option Disabled (factory default setting)

- Press the DELICATES/BULKY ( $\wedge$ ) or the COLD (v) keypad to change the current status.
- Press the START (enter) keypad when the correct value appears in the display. The new value is saved and the next option will appear in the display.

### Drop Off Mode **dr oP**

This option allows the owner to limit machine use to an attendant without requiring vend. Refer to *Drop-Off Mode* for more details.

- Control must be in Manual Mode. Refer to *How to Enter the Manual Mode*.
- Press the DELICATES/BULKY ( $\wedge$ ) or the COLD (v) keypad until **Pr o 9** appears in the display. Press the START (enter) keypad, and **Rt 5 1** will appear in the display.
- Press the DELICATES/BULKY ( $\wedge$ ) or the COLD (v) keypad to scroll through the programmable options until **dr oP** appears in the display.
- When **dr oP** appears in the display, press the START (enter) keypad. The current Drop Off Mode status will appear in the display.

**oN** = Option Enabled

**oFF** = Option Disabled (factory default setting)

- Press the DELICATES/BULKY ( $\wedge$ ) or the COLD (v) keypad to change the current status.
- Press the START (enter) keypad when the correct value appears in the display. The new value is saved and the next option will appear in the display.

### Out of Order **oUt**

This option allows the owner to disable machine use by displaying an out of order message.

- Control must be in Manual Mode. Refer to *How to Enter the Manual Mode*.
- Press the DELICATES/BULKY ( $\wedge$ ) or the COLD (v) keypad until **Pr o 9** appears in the display. Press the START (enter) keypad, and **Rt 5 1** will appear in the display.
- Press the DELICATES/BULKY ( $\wedge$ ) or the COLD (v) keypad to scroll through the programmable options until **oUt** appears in the display.

## Programming Control

4. When **oUe** appears in the display, press the START (enter) keypad. The current Out of Order status will appear in the display.

**on** = Option Enabled

**oFF** = Option Disabled (factory default setting)

5. Press the DELICATES/BULKY (**Λ**) or the COLD (**v**) keypads to change the current status.
6. Press the START (enter) keypad when the correct value appears in the display. The new value is saved and the next option will appear in the display.



# Collecting Audit Information

This feature allows the owner to retrieve audit information stored in the washer by pressing a sequence of pads on the control.

## How to Enter Audit Feature

There are two methods the owner can use to enter the Audit Feature.

### Entering the Audit Feature by Manual Mode

1. Control must be in Manual Mode. Refer to *How to Enter the Manual Mode*.
2. Press the DELICATES/BULKY (Λ) or the COLD (V) keypad to scroll through the programmable options until **AUDIT** appears in the display.
3. Press the START keypad and **CYCLES** will appear in the display.

### Entering the Audit Feature with the Coin Vault Open

1. Open coin vault. Make sure service door is closed.
2. Press the START (enter) keypad.

### How to Read Audit Data

1. Press the DELICATES/BULKY (Λ) or the COLD (V) keypad to scroll through the programmable options. Refer to *Table 25*.
2. When the desired option appears in the display press the START (enter) keypad. The current value will appear in the display.
3. Press the WARM keypad. The display will return to the audit option list.

Programmable Options

<b>CYCLES</b>	Total Number of Machine Cycles
<b>Co in 1</b>	Total Number of Coins #1
<b>Co in 2</b>	Total Number of Coins #2
<b>PULSE</b>	Total Number of Start Pulses
<b>rAPCYC</b>	Total Number of Rapid Advance Cycles
<b>rUnHrS</b>	Total Number of Run Hours

Table 25 *continues...*

<b>rCo in 1</b>	Resettable Coin #1 Count
<b>rCo in 2</b>	Resettable Coin #2 Count
<b>rCYCLE</b>	Resettable machine Cycle Count

Table 25

### How to Exit Audit Feature

1. Press the WARM (<) keypad until the control returns to Ready Mode.
2. To exit Audit Feature when using Coin Vault Open method, owner must close coin vault. The control will then return to Ready Mode.

# Manual Reset

This feature allows the owner to reset the washer control's programming data to the factory default settings by pressing a sequence of pads on the control.

## How to Enter Manual Reset

1. Control must be in Manual Mode. Refer to *How to Enter the Manual Mode*.
2. Press the DELICATES/BULKY (Λ) or the COLD (V) keypad to scroll through the programmable options until **rESEt** appears in the display.
3. Press the START (enter) keypad. **gLabAL** will appear in the display.
4. Press the DELICATES/BULKY (Λ) or the COLD (V) keypad to scroll through the manual reset options. Refer to *Table 26*.
5. Press the START (enter) keypad. **no** will appear in the display.
6. Press the DELICATES/BULKY (Λ) or the COLD (V) keypad to change the value to **9E5**.
7. Press the START (enter) keypad when the correct value appears in the display.

### Programmable Options

<b>gLabAL</b>	Global Programming Parameters
<b>rCYC-</b>	Individual Cycles Sub Menu
<b>rCYC 1</b>	Cycle 1
<b>rCYC 2</b>	Cycle 2
<b>rCYC 3</b>	Cycle 3
<b>rCYC 4</b>	Cycle 4
<b>rCYC 5</b>	Cycle 5
<b>rCYC 6</b>	Cycle 6
<b>rCYC 7</b>	Cycle 7
<b>rCYC 8</b>	Cycle 8
<b>rCYC 9</b>	Cycle 9
<b>ALLCYC</b>	All Cycles
<b>ALL</b>	All Cycles and Global Programming Parameters

Table 26

# Testing Machine and Electronic Control Functions

This feature allows the owner to run diagnostic tests on various washer operations without servicing the washer. The following tests are available:

- Front-End Control Software Version # Test
- Drive Board #1 Software Version Test
- Service Door Switch Input Test
- Coin Vault Switch Input Test
- Coin Drop #1 Input Test
- Coin Drop #2 Input Test
- Vend Connection Header Present Input Test
- Start Pulse Input Test
- Door Switch Input Test\*
- Door Lock Switch Input Test\*
- Show Fill Time Test
- Show Drain Time Test
- Out of Balance Switch Input Test
- External Output Test\*
- Water Purge Test\*
- Water Leak Detection Test\*
- Water Level Test
- DC Bus Voltage Test
- AC Mains Voltage Test
- Machine Configuration #1 Display Test
- Machine Configuration #2 Display Test
- Machine Configuration #3 Display Test
- Machine Configuration #4 Display Test
- Machine Configuration #5 Display Test

\* Tests can only be entered when in Start or Ready Mode.

For an overview of the manual diagnostic test feature, refer to the flowchart on the following page.

## How to Enter Testing Feature

1. Control must be in Manual Mode. Refer to *How to Enter the Manual Mode*.
2. Press the DELICATES/BULKY (Λ) or the COLD (V) keypad to scroll through the programmable options until **d1 R9** appears in the display.
3. Press the START (enter) keypad. Display will change to **d 1** indicating the control software version number test.
4. Press the DELICATES/BULKY (Λ) or the COLD (V) keypad to scroll through the diagnostic test options.

## How to Start Tests

1. To start a diagnostic test, refer to the quick reference chart below.
2. Press the START (enter) keypad when the desired test number is displayed. For detailed information on each test, read the appropriate description.

## How to Exit Testing Feature

Press the WARM (<) keypad until the display returns to the previous mode of operation.

## Diagnostic (Testing) Mode – Quick Reference Chart

Test Number	Diagnostic Mode	Display
<b>d 1</b>	Control Software Version # Test	<b>5 ---</b>
<b>d 2</b>	Input/Output Board Software Version # Test	<b>ob --</b>
<b>d 3</b>	Driver Board #1 Software Version Test	<b>db --</b>
<b>d 8</b>	Service Door Opening Test	<b>5 oP</b> or <b>5 [L</b>
<b>d 9</b>	Coin Vault Opening Test	<b>u oP</b> or <b>u [L</b>
<b>d 10</b>	Coin Drop #1 Input Test	<b>[ 1 --</b>

Table 27 continues...

<b>Test Number</b>	<b>Diagnostic Mode</b>	<b>Display</b>
<i>d 11</i>	Coin Drop #2 Input Test	<i>CL --</i>
<i>d 12</i>	Vend Header Present Status Test	<i>CH oP</i> (Open) or <i>CH CL</i> (Closed)
<i>d 13</i>	Start Pulse Test	<i>St --</i>
<i>d 15</i>	Door Switch Input Test	<i>dr oP, dr CL</i>
<i>d 16</i>	Door Lock Input Test	<i>CLoSE door</i>
<i>d 17</i>	Show Fill Time Test	<i>FL ---</i>
<i>d 18</i>	Show Drain Time Test	<i>dr ---</i>
<i>d 22</i>	Out of Balance Switch Input Test	<i>bA oP</i> or <i>bA CL</i>
<i>d 23</i>	External Output Test	<i>ES -</i> or <i>ES -on</i>
<i>d 24</i>	Water Purge Test	<i>CLoSE, door, PURGE</i> or <i>FLUSH</i>
<i>d 25</i>	Water Leak Detection Test	<i>PRSS, E Ld, E LF</i> or <i>Ld</i> <i>CLoSE, door</i>
<i>d 26</i>	Water Level Test	<i>L ---</i> or <i>L ---.</i>
<i>d 27</i>	DC Bus Voltage Test	<i>---.-</i>
<i>d 28</i>	AC Mains Voltage Test	<i>---.-</i>
<i>d 29</i>	Machine Configuration #1 Display Test	<i>A ---</i>
<i>d 30</i>	Machine Configuration #2 Display Test	<i>b ---</i>
<i>d 31</i>	Machine Configuration #3 Display Test	<i>C ---</i>
<i>d 32</i>	Machine Configuration #4 Display Test	<i>d ---</i>
<i>d 33</i>	Machine Configuration #5 Display Test	<i>E ---</i>

Table 27

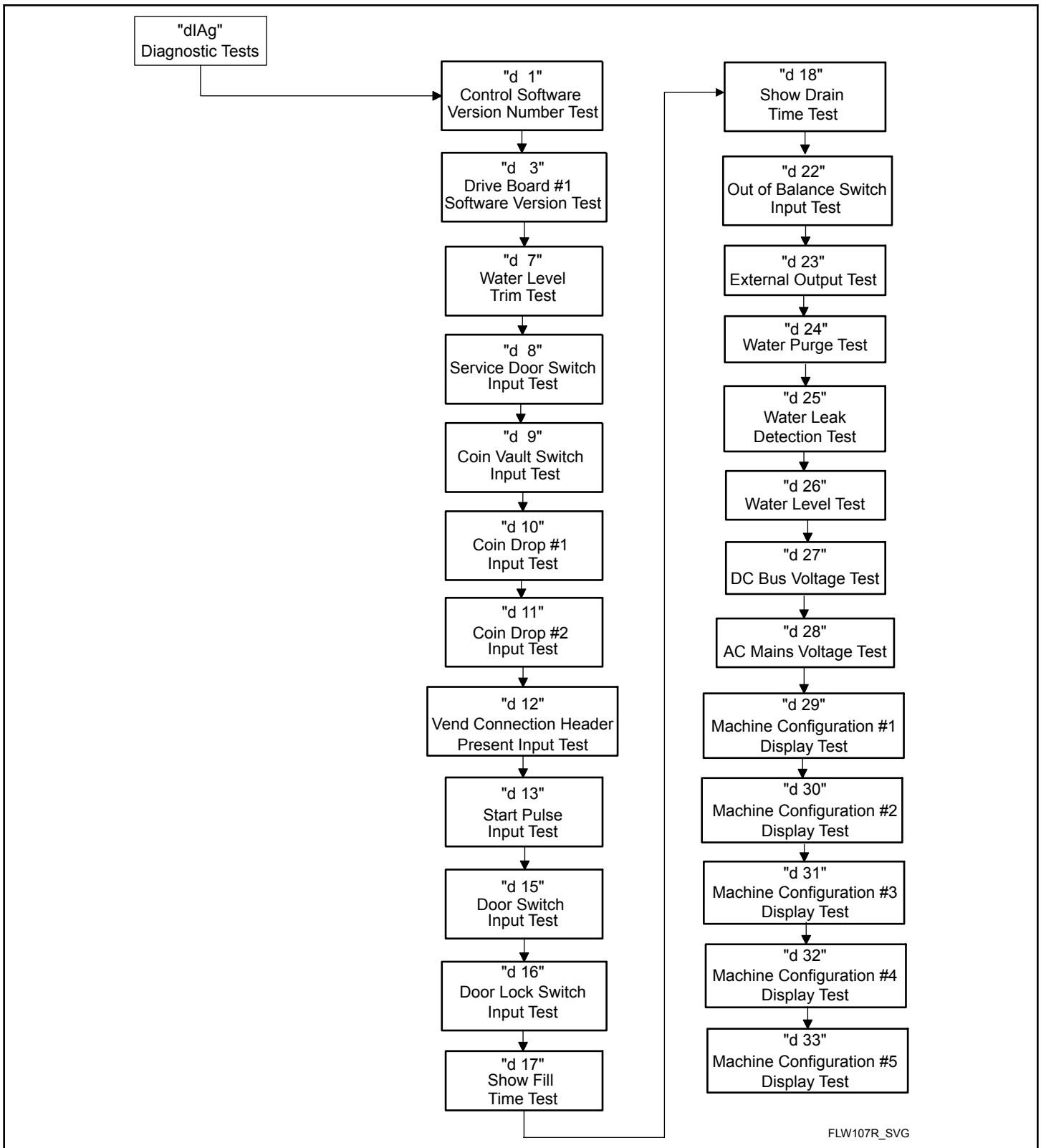

FLW107R\_SVG

Figure 15

## Diagnostic Test Descriptions

### Control Software Version Number Test *d 1*

This option displays the control software version number. To start test, control must be in the Testing Mode. Refer to *How to Enter Testing Feature* at the beginning of this section.

To enter, press the START (enter) keypad. The display will show **5 HH** where **HH** is the software version number.

To exit the Software Version Number Test, press the WARM (<) keypad. The control will return to the Testing Mode.

### Drive Board #1 Software Test *d 3*

This option displays the drive board software version number. To start test, control must be in the Testing Mode. Refer to *How to Enter Testing Feature* at the beginning of this section.

To enter, press the START (enter) keypad. The display will show **db IHH** where **HH** is the software version number.

To exit the Drive Board #1 Version Test, press the WARM (<) keypad. The control will return to the Testing Mode.

### Water Level Trim Test *d 7*

This test checks the water level trim value. To start test, control must be in the Testing Mode. Refer to *How to Enter Testing Feature* at the beginning of this section.

To enter, press the START (enter) keypad. The display will show **Er .IHHH** where **XX** is the trim value in 0.1 inch precision where a value of **05** would equal 0.5 inches. If the right most decimal point is lit, the trim value is negative.

To exit the Water Level Trim Test, press the WARM (<) keypad. The control will return to the Testing Mode.

### Service Door Opening Test *d B*

This option tests the service door switch. To start test, control must be in the Testing Mode. Refer to *How to Enter Testing Feature* at the beginning of this section.

To enter, press the START (enter) keypad. The display will show **5 oP** when the service door switch is open and **5 CL** when the service door switch is closed.

The service door switch has to be closed for at least one second and opened for at least one second for the display to change. This test will add a count to the service door opening counter for the audit and save the date/time for each opening.

To exit the Service Door Opening Test, press the WARM (<) keypad. The control will return to the Testing Mode.

### Coin Vault Opening Test *d 9*

This option tests the coin vault switch. To start test, the control must be in the Testing Mode. Refer to *How to Enter Testing Feature* at the beginning of this section.

To enter, press the START (enter) keypad. The display will show **u oP** when the coin vault switch is open and **u CL** when the coin vault switch is closed.

The coin vault switch has to be closed for at least one second and opened for at least one second for the display to change. This test will add a count to the coin vault opening counter for the audit and save the time/date for each opening.

To exit the Coin Vault Opening Test, press the WARM (<) keypad. The control will return to the Testing Mode.

### Coin Drop 1 Input Test *d 10*

This option tests coin drop #1. To start test, control must be in the Testing Mode. Refer to *How to Enter Testing Feature* at the beginning of this section.

To enter, press the START (enter) keypad. The display will show **CI HH**. The **HH** will show the number of coins entered and will increment one for each coin entered in coin drop #1.

**NOTE: Coins entered in test mode will not increment the total # of coins counter that is accessed in the audit feature.**

To exit the Coin Drop #1 Input Test, press the WARM (<) keypad. The control will return to the Testing Mode.

### Coin Drop 2 Input Test *d 11*

This option tests coin drop #2. To start test, control must be in the Testing Mode. Refer to *How to Enter Testing Feature* at the beginning of this section.

To enter, press the START (enter) keypad. The display will show **CI HH**. The **HH** will show the number of coins entered and will increment one for each coin entered in coin drop #2.

**NOTE: Coins entered in test mode will not increment the total # of coins counter that is accessed in the audit feature.**

To exit the Coin Drop #2 Input Test, press the WARM (<) keypad. The control will return to the Testing Mode.

### Vend Connection Header Present Test *d 12*

This option tests the vend header connection. To start test, control must be in Testing Mode. Refer to *How to Enter Testing Feature* at the beginning of this section.

To enter, press the START (enter) keypad. The display will show **CH oP** when the wiring connection is open and **CH CL** when the connection is closed.

To exit Vend Connection Header Present Test, press the WARM (<) keypad. The control will return to the Testing Mode.

### Start Pulse Test *d 13*

This option tests the Start Pulse. To start test, control must be in the Testing Mode. Refer to *How to Enter Testing Feature* at the beginning of this section.

To enter, press the START (enter) keypad. The display will show **5t HH**. The **HH** will show the number of pulses entered. This test will add counts to the total number of Start Pulses counter. Refer to *Collecting Audit Information*.

To exit the Start Pulse Test, press the WARM (<) keypad. The control will return to the Testing Mode.

### Door Switch Input Test d 15

This test will display whether the washer door is open or closed.

To start test, control must be in the Testing Mode. Refer to *How to Enter Testing Feature* at the beginning of this section.

To enter, press the START (enter) keypad. If the door is closed, the display will show **dr CL**. If the door is open, the display will show **dr oP**.

To exit the test, press the WARM (<) keypad. The control will return to the Testing Mode.

### Door Lock Input Test d 16

This test will display whether the door is locked or unlocked.

To start test, control must be in the Testing Mode. Refer to *How to Enter Testing Feature* at the beginning of this section.

To enter, close the door and press the START (enter) keypad. The control will lock the door. If the door is open, the display will show **CLoSE** and **door**. The door must be closed to enter test.

If the door is unlocked, the display will show **dr UL**. After the door is locked, the display shows **dr Lo** and 5 seconds later the door will unlock. This sequence is repeated every time the START (enter) keypad is pressed.

To exit the test, press the WARM (<) keypad. The control will return to the Testing Mode.

### Show Fill Time Test d 17

This test will display the average fill time. This average will be calculated by taking the average of the last 10 fill times.

To start test, control must be in the Testing Mode. Refer to *How to Enter Testing Feature* at the beginning of this section.

To enter, press the START (enter) keypad. The display will show **FL HHH**. The **HHH** will be the average fill time in seconds.

To exit the Show Fill Time Test, press the WARM (<) keypad. The control will return to the Testing Mode.

### Show Drain Time Test d 18

This test will display the average drain time. This average will be calculated by taking the average of the last 10 drain times.

To start test, control must be in the Testing Mode. Refer to *How to Enter Testing Feature* at the beginning of this section.

To enter, press the START (enter) keypad. The display will show **dr HHH**. The **HHH** will be the average fill time in seconds.

To exit the Show Drain Time Test, press the WARM (<) keypad. The control will return to the Testing Mode.

### Out of Balance Switch Test d 22

This test displays whether the out of balance switch is open or closed. To start test, control must be in the Testing Mode. Refer to *How to Enter Testing Feature* at the beginning of this section.

To enter, press the START (enter) keypad. The display will show **br oP** if the switch is open or **br CL** if the switch is closed.

To exit the Out of Balance Switch Test, press the WARM (<) keypad. The control will return to the Testing Mode.

### External Outputs Test d 23

This test will allow any one of the external outputs to be selected. To start test, control must be in the Testing Mode. Refer to *How to Enter Testing Feature* at the beginning of this section.

To enter, press the START (enter) keypad. The display will show **E5 H** where X is the output number. Press the DELICATES/BULKY (Λ) or the COLD (V) keypad to scroll through the outputs.

Press the START (enter) keypad to energize the selected external output. **E5 Hon** will be displayed. Press the START (enter) again or the WARM (<) keypad to turn off the selected external output.

To exit the External Outputs Test, press the WARM (<) keypad. The control will return to the Testing Mode.

### Water Purge Test d 24

This test allows the user to test water removal from the machine. To start test, control must be in the Testing Mode. Refer to *How to Enter Testing Feature* at the beginning of this section.

To enter, press the START (enter) keypad. The display will show **PURGE** and the START (enter) keypad LED will flash. Begin the test by pressing START (enter). If the door is open, **CLoSE**, **door** will be displayed to prompt the user to close the loading door. When the START (enter) pad is pressed with the door closed, the door will lock and **FLUSH** will be displayed.

The control will energize all water valves and supply outputs while keeping the drain valves open or the pump energized. Press any keypad to end the test. The test will end automatically after 2 minutes. The door will unlock and the control will display **PURGE**.

To exit the Water Purge Test, press the WARM (<) keypad. The control will return to the Testing Mode.

### Water Leak Detection Test d 25

This test allows the user to check for water leaking from the machine. To start test, control must be in the Testing Mode. Refer to *How to Enter Testing Feature* at the beginning of this section.

To enter, press the START (enter) keypad. The display will show **Ld** and the START (enter) keypad LED will flash. Begin the test by pressing START (enter). If the door is open, **CLoSE**, **door**

will be displayed to prompt the user to close the loading door. When the START (enter) pad is pressed with the door closed, the door will lock and the test will begin. With the drain valve closed or the pump off, the cold water valve will turn on until the Low water level is reached.

After a 10 second pause to allow the water pressure to stabilize, the control will record the current water level from the electronic water level sensing input and continue to monitor the water level for two minutes. The display will show a sequence of horizontal LED segments to indicate it is monitoring the water level.

After two minutes, the control will compare the ending water level with the level at the start. If the water level has dropped or raised, the display will show **E Ld** to signify a drain leak or **E LF** to signify a fill leak. If the water level has not dropped or raised, the display will show **PASS**.

Then the drain will open or the pump will turn on. When the water has been drained or pumped out of the machine, the control will unlock the door and display the result message. The error message is an indication to the machine owner that there should be service attention devoted to the fill valve or drain valve/pump on the machine to diagnose where the water leak is originating.

To stop the test while it is running, press the START (enter) keypad. The test will stop, the machine will drain the water, unlock the door, and the control will go back to the beginning of the test sequence.

To exit the Water Leak Detection Test, press the WARM (<) keypad. The control will return to the Testing Mode.

### Water Level Test d 25

This test displays the water level as determined by the water level sensor. To start test, control must be in the Testing Mode. Refer to *How to Enter Testing Feature* at the beginning of this section.

To enter, press the START (enter) keypad. The display will show **L HHH** where **HHH** is the water level in 0.1 inch precision where a value of 05 equals 0.5 inches. If the rightmost decimal point is lit, the value is negative.

To exit the Water Level Test, press the WARM (<) keypad. The control will return to the Testing Mode.

### DC Bus Voltage Test d 27

This will display the DC Bus Voltage. To start test, control must be in the Testing Mode. Refer to *How to Enter Testing Feature* at the beginning of this section.

To enter, press the START (enter) keypad. The display will show **HHHH** which is the voltage in 0.1 Volt precision.

To exit the DC Bus Voltage Test, press the WARM (<) keypad. The control will return to the Testing Mode.

### AC Mains Voltage Test d 28

This will display the AC Mains Voltage. To start test, control must be in the Testing Mode. Refer to *How to Enter Testing Feature* at the beginning of this section.

To enter, press the START (enter) keypad. The display will show **HHHH** which is the voltage in 0.1 Volt precision.

To exit the AC Mains Voltage Test, press the WARM (<) keypad. The control will return to the Testing Mode.

### Configuration 1 Display Test d 29

This option shows the machine configuration values. To start test, control must be in the Testing Mode. Refer to *How to Enter Testing Feature* at the beginning of this section.

To enter, press the START (enter) keypad. For configuration value #1, the display will show **R HHH**. **HH** is a number corresponding to whether or not coin drops are connected, a card reader or network board are connected, or whether the life-test jumper is present. Refer to *Table 28*.

To exit a Configuration Display Test, press the WARM (<) keypad. The control will return to the Testing Mode.

Each column of the table below contains a unique combination of the words "YES" and "NO" that indicates if that column's connection is present.



Configura- tion Value	Life Test Jumper Present	Comm Board "B" Header Present	Comm Board "A" Header Present	Vend Con- nection Present	Coin Drop #2 Present	Coin Drop #1 Present
0	NO	NO	NO	NO	NO	NO
1	NO	NO	NO	NO	NO	YES
2	NO	NO	NO	NO	YES	NO
3	NO	NO	NO	NO	YES	YES
4	NO	NO	NO	YES	NO	NO
5	NO	NO	NO	YES	NO	YES
6	NO	NO	NO	YES	YES	NO
7	NO	NO	NO	YES	YES	YES
8	NO	NO	YES	NO	NO	NO
9	NO	NO	YES	NO	NO	YES
10	NO	NO	YES	NO	YES	NO
11	NO	NO	YES	NO	YES	YES
12	NO	NO	YES	YES	NO	NO
13	NO	NO	YES	YES	NO	YES
14	NO	NO	YES	YES	YES	NO
15	NO	NO	YES	YES	YES	YES
16	NO	YES	NO	NO	NO	NO
17	NO	YES	NO	NO	NO	YES
18	NO	YES	NO	NO	YES	NO
19	NO	YES	NO	NO	YES	YES
20	NO	YES	NO	YES	NO	NO
21	NO	YES	NO	YES	NO	YES
22	NO	YES	NO	YES	YES	NO
23	NO	YES	NO	YES	YES	YES
24	NO	YES	YES	NO	NO	NO
25	NO	YES	YES	NO	NO	YES
26	NO	YES	YES	NO	YES	NO
27	NO	YES	YES	NO	YES	YES
28	NO	YES	YES	YES	NO	NO
29	NO	YES	YES	YES	NO	YES
30	NO	YES	YES	YES	YES	NO

Table 28 *continues...*

<b>Configura- tion Value</b>	<b>Life Test Jumper Present</b>	<b>Comm Board "B" Header Present</b>	<b>Comm Board "A" Header Present</b>	<b>Vend Con- nection Present</b>	<b>Coin Drop #2 Present</b>	<b>Coin Drop #1 Present</b>
31	NO	YES	YES	YES	YES	YES
32	YES	NO	NO	NO	NO	NO
33	YES	NO	NO	NO	NO	YES
34	YES	NO	NO	NO	YES	NO
35	YES	NO	NO	NO	YES	YES
36	YES	NO	NO	YES	NO	NO
37	YES	NO	NO	YES	NO	YES
38	YES	NO	NO	YES	YES	NO
39	YES	NO	NO	YES	YES	YES
40	YES	NO	YES	NO	NO	NO
41	YES	NO	YES	NO	NO	YES
42	YES	NO	YES	NO	YES	NO
43	YES	NO	YES	NO	YES	YES
44	YES	NO	YES	YES	NO	NO
45	YES	NO	YES	YES	NO	YES
46	YES	NO	YES	YES	YES	NO
47	YES	NO	YES	YES	YES	YES
48	YES	YES	NO	NO	NO	NO
49	YES	YES	NO	NO	NO	YES
50	YES	YES	NO	NO	YES	NO
51	YES	YES	NO	NO	YES	YES
52	YES	YES	NO	YES	NO	NO
53	YES	YES	NO	YES	NO	YES
54	YES	YES	NO	YES	YES	NO
55	YES	YES	NO	YES	YES	YES
56	YES	YES	YES	NO	NO	NO
57	YES	YES	YES	NO	NO	YES
58	YES	YES	YES	NO	YES	NO
59	YES	YES	YES	NO	YES	YES
60	YES	YES	YES	YES	NO	NO
61	YES	YES	YES	YES	NO	YES

Table 28 *continues...*

Configuration Value	Life Test Jumper Present	Comm Board "B" Header Present	Comm Board "A" Header Present	Vend Connection Present	Coin Drop #2 Present	Coin Drop #1 Present
62	YES	YES	YES	YES	YES	NO
63	YES	YES	YES	YES	YES	YES

Table 28

**Configuration 2 Display Test d 30**

This option is not used on this model.

**Configuration 3 Display Test d 31**

This option is not used on this model.

**Configuration 4 Display Test d 32**

This option shows the user which dipswitches are set on the control.

To start test, control must be in the Testing Mode. Refer to *How to Enter Testing Feature* at the beginning of this section.

To Enter, press the START (enter) keypad. The display will show **d HHH** with **HHH** representing a configuration value as shown in *Table 29*.

If supply voltage is 100-127 Volt per phase, the voltage configuration should be 120 Volt.

If supply voltage is 200-240 Volt per phase, the voltage configuration should be 240 Volt.

To exit Machine Configuration 4 Display Test, press the WARM (<) keypad. The control will return to the Testing Mode.

Each column in the table below contains a unique combination of the words "ON" and "OFF" that indicates if that column's dipswitch is set on or off when the value is displayed.

Configuration Value	Dipswitch 8 Pump (OFF) Gravity Drain (ON)	Dipswitch 7 Heater Disabled (OFF) Heater Enabled (ON)	Dipswitch 3 Payment System Not Present (OFF) Payment System Present (ON)	Dipswitch 2 Energy Cycle	Dipswitch 1 120 Volt Supply (OFF) 240 Volt Supply (ON)
0	OFF	OFF	OFF	OFF	OFF
1	OFF	OFF	OFF	OFF	ON
2	OFF	OFF	OFF	ON	OFF
3	OFF	OFF	OFF	ON	ON
4	OFF	OFF	ON	OFF	OFF
5	OFF	OFF	ON	OFF	ON
6	OFF	OFF	ON	ON	OFF
7	OFF	OFF	ON	ON	ON
64	OFF	ON	OFF	OFF	OFF
65	OFF	ON	OFF	OFF	ON

Table 29 continues...

Configuration Value	Dipswitch 8 Pump (OFF) Gravity Drain (ON)	Dipswitch 7 Heater Disabled (OFF) Heater Enabled (ON)	Dipswitch 3 Payment System Not Present (OFF) Payment System Present (ON)	Dipswitch 2 Energy Cycle	Dipswitch 1 120 Volt Supply (OFF) 240 Volt Supply (ON)
66	OFF	ON	OFF	ON	OFF
67	OFF	ON	OFF	ON	ON
68	OFF	ON	ON	OFF	OFF
69	OFF	ON	ON	OFF	ON
70	OFF	ON	ON	ON	OFF
71	OFF	ON	ON	ON	ON
128	ON	OFF	OFF	OFF	OFF
129	ON	OFF	OFF	OFF	ON
130	ON	OFF	OFF	ON	OFF
131	ON	OFF	OFF	ON	ON
132	ON	OFF	ON	OFF	OFF
133	ON	OFF	ON	OFF	ON
134	ON	OFF	ON	ON	OFF
135	ON	OFF	ON	ON	ON
192	ON	ON	OFF	OFF	OFF
193	ON	ON	OFF	OFF	ON
194	ON	ON	OFF	ON	OFF
195	ON	ON	OFF	ON	ON
196	ON	ON	ON	OFF	OFF
197	ON	ON	ON	OFF	ON
198	ON	ON	ON	ON	OFF
199	ON	ON	ON	ON	ON

Table 29

### Configuration 5 Display Test *d 33*

This option is not used on this model.

## Factory Test

### To Enter Factory Test

1. Be certain control is in Ready Mode or Start Mode and access panel or coin vault is open.
2. While pressing and holding the HEAVY modifier keypad with one hand, press the HOT keypad with the other hand.
3. When the control enters Factory Test, it will display the first test step, Machine Type.
4. The control will advance through the sequence of test steps whenever START (enter) is pressed, with the exception of the Keypad Test and Pressure Sensor Test. Refer to the table below for all tests in the Factory Test.

## To Exit Factory Test

To exit a test step, disconnect the machine from electrical power.

Factory Test Quick Reference Chart		
Display	Test Mode	Comments
<i>FL</i>	Control Type	FL is the control type.
<i>S H H H</i>	Software Version Number	XXX is the control version number.
<i>R H</i>	Control Level	The control will display the control level as Display 1.
<i>d-r-A</i> , or <i>P U N P</i>	Drain Type	The control will show <i>d-r-A</i> , if it is configured for a gravity drain. It will show <i>P U N P</i> if it is configured as an electric pump machine. The control will remain in this mode until the Start keypad is pressed.
<i>H E A T</i>	Heater Installed	The control will show <i>H E A T</i> if it is configured for a Water Heater. The control will skip this step if it is not configured for a Water Heater. The control will remain in this mode until the Start keypad is pressed.
<i>u o P</i> or <i>u C L</i>	Coin Vault Test	<i>u o P</i> is displayed when coin vault switch is open. <i>u C L</i> is displayed when coin vault switch is closed.
<i>S o P</i> or <i>S C L</i>	Service Door Switch Test	<i>S o P</i> is displayed when service door switch is open. <i>S C L</i> is displayed when service door switch is closed.
<i>C H C H</i>	Coin Drop Test	X is the number of coins entered. Coin drop #1 is shown on the left of the display and coin drop #2 is shown on the right of the display.
<i>C A R d</i> , <i>L C S U</i> , or <i>S U</i>	Card Reader Test	<i>C A R d</i> is displayed when a card reader is completed but not driving the display. <i>L C S U</i> is displayed when a programming/setup card is needed. <i>S U</i> is displayed when a programming/setup card was successful.
<i>P A H H</i>	Keypad Test	XX is the number of the keypad being pressed. You need to press all keypads to advance to the next step.

Table 30 continues...

Factory Test Quick Reference Chart		
Display	Test Mode	Comments
<b>BBBBBB</b>	Display Test	All LEDs and display segments will light.
<b>dr oP</b> or <b>dr CL</b>	Door Switch Test	<b>dr oP</b> is displayed when loading door is open. <b>dr CL</b> is displayed when loading door is closed.
<b>dbHH</b>	Driver Type and Driver Version Number	Driver board version display when XX is the driver software version number.
<b>drLo</b> or <b>drUL</b>	Door Lock Test	When step is entered, control will lock door and will then check to make sure door is locked. <b>drLo</b> is displayed if door is locked. <b>drUL</b> is displayed if door is unlocked.
<b>CLdE</b>	Cold/Detergent Fill	Cold Water Fill valve and Detergent/ Bleach valve are turned on.
<b>HoSF</b>	Hot/Softener Fill	Hot Water Fill valve and Softener valve are turned on.
<b>PrSr</b>	Pressure Sensor Fill	This step checks the water level input. The display shows <b>PrSt</b> , and all water valves turn on. When the Water Fill Level is satisfied, the water valves are turned off. If the Start key is pressed and the Water Fill level is not satisfied, the control will not advance to the next cycle step.
<b>oFLo</b>	Overflow Test	All water and dispenser valves are turned on. When the overflow level is reached the water valves are turned off. If the START (enter) key is pressed and the Water Fill level is not satisfied, the control will not advance to the next cycle step.
<b>LoAG</b>	Low Agitate	Machine enters low agitate.
<b>rERg</b>	Regular Agitate	Machine enters regular agitate.
<b>PUNP</b> or <b>drA i</b>	Pump/Gravity Drain Test	Pump is turned on or gravity drain is opened. The control will not advance to next step until drum is empty.
RPM speed displayed <b>HHHH</b>	Spin Test	Machine will attempt to spin up to 1200 RPMs.

Table 30 continues...

Factory Test Quick Reference Chart		
Display	Test Mode	Comments
<i>brAY</i>	Breakaway	<p>Motor runs at Regular Agitate speed. When door unlocks, open door to exit test.</p> <p>Start keypad must be pressed three times to advance to next step. First press turns off water, second press stops motor and third press unlocks the door.</p>
<i>Pd</i>	Power Down	<p>This is the final step of Factory Test. The control will display <i>Pd</i> to signify that factory test has been completed and that the user can safely unplug the machine. Cycling power to the machine is the only way to resume normal operation and the control will stay in this state indefinitely until that time.</p>

Table 30

# Error Codes

Following is a list of possible error codes for an electronic control. Errors beginning with **E**, refer to external device Infra-red communication errors. Errors beginning with **EC** refer to card reader errors. All other errors refer to machine errors.

**NOTE: Fatal Errors will show *out of order* along with the error on the display.**

Error Codes		
Display	Description	Cause/Corrective Action
<b>E .01</b>	Transmission Failure	Communication failure. Re-aim external device and try again.
<b>E .02</b>	Time-out Error	Communication failure. Re-aim external device and try again.
<b>E .03</b>	Invalid Command Code	Communication successful, but the command was not valid for this machine type, or the control could not perform the command in its current mode of operation. Ensure data is for current machine type and control is in correct mode.
<b>E .04</b>	Expecting Upload Request	Communication failure. Re-aim external device and try again.
<b>E .05</b>	Invalid or Out-of-Range Data	The value in at least one of the programming options is invalid or out of range. Re-check the programming option's value and try again.
<b>E .09</b>	CRC-16 Error	Communication failure. Re-aim external device and try again.
<b>E .0A</b>	Framing Error	Communication error. Re-aim external device and try again.
<b>E .0C</b>	Time-out Exceeded	Communication error. Re-aim external device and try again.
<b>E .0E</b>	Encryption Error	Communication error. Re-aim external device and try again. If the problem persists, check that the security code is correct.
<b>E .0F</b>	Infra-red Disabled	Communication failure or infra-red is disabled. Manually enable infra-red on control or re-aim external device and try again.
<b>EC<math>\overline{H}</math>H</b>	Payment System Error	The Front-end control communicates with the Payment System in order to perform vending transactions. If an error should occur, which, terminates communication during a transaction, the LED Display will show <b>EC<math>\overline{H}</math>H</b> for a control generated error, where the <b>HH</b> represents an error code.
<b>EC02</b>	Time-out Error	Communication failure. Try card again.
<b>EC03</b>	Invalid Command Code	Communication successful, but the command was not valid for this machine type, or the control could not perform the command in its current mode of operation. Ensure data is for current machine type and control is in correct mode.
<b>EC05</b>	Invalid or Out-of-Range Data	The value in at least one of the programming options is invalid or out of range. Re-check the programming option's value and try again.

*Table continues...*



Error Codes		
Display	Description	Cause/Corrective Action
<i>EC 11</i>	No Card Reader Initialization	Communication is valid, but there is no card reader initialization. Power down, power up and try again.
<i>EC 1B</i>	No Communication	Card reader is initialized, communication lost. Power down, power up and try again. If error persists, replace control or card reader.
<i>EC 19</i>	No Card Reader Communication	Communication failure. Power down, power up and try again. If error persists, replace control or card reader.
Right most decimal point Lit	Network Communication Error	Communication problem. Wait for 1.5 minutes for error to clear. If error doesn't clear, power-down and power-up the machine. If error persists, replace control or network board.
Right most decimal point Lit	Water Leak Detection Error or Slow Drain Detection Error	Water leak test has detected a water leak during a cycle or slow drain is detected in the drain step of a running cycle. The decimal point will remain lit after the error display has expired. Clear the decimal point by pressing the START keypad three times within five seconds or by cycling the power to the machine.
Right most decimal point blinking	Machine ID Error	Machine ID is no longer communicating with the control. Check Machine ID connection.
Left most decimal point blinking one second on/one second off	Max Speed Fail Error	If the final spin fails to reach 1200 RPM, the control will set the Max Speed Fail Error immediately when entering End of Cycle Mode to alert that the max speed was not reached in the cycle.  This error will be cleared when vend is entered, a key is pressed, the door is opened, or when higher priority errors are cleared.
<i>ALArn</i>	Break-in Alarm Error	Check the service door and coin vault switches.
<i>aFF</i>	Break-in Alarm Shutdown Error	Check the service door and coin vault switches.
<i>E FL</i>	Fill Error	Fill level is not reached within 30 minutes (or other programmed length of time) in any fill step.
<i>E dL</i>	Door Lock Fatal Error	Door is unlocked during a running cycle. To clear this error, cycle power to the machine.
<i>E dL 1</i>	Door Lock Non-Fatal Error	If the door fails to lock in twenty (20) seconds in Door Locking Mode after the Drive has been enabled the control will turn off all outputs and show the error <i>E dL 1</i> . To clear this error the door must either open or lock.
<i>E dL2</i>	Door Unlock Non-Fatal Error	If the door fails to unlock in 20 seconds, with a solenoid type door lock, after the drum has stopped spinning, and all other outputs have been turned off, the control will show error <i>E dL2</i> . To clear this error the door must unlock or open.
<i>E door</i>	Door Opened During A Running Cycle	Control detects door open and door locked inputs high. Can be caused by pulling on door while locked or about to lock. Correct inoperative door locking system. Unpower machine to clear error.

*Table continues...*

Error Codes		
Display	Description	Cause/Corrective Action
<i>E Ub1</i>	Non-Fatal Unbalance Error	Unable to balance load. Redistribute load and run cycle.
<i>E Ub2</i>	Fatal Unbalance Error	Wires to unbalance switch broken or not connected.
<i>CLoSE door</i>	Door Open Indicator	Door is not closed during an active cycle. If door is closed, check for improper wiring or faulty door switch.
<i>Co in Error</i>	Coin Error	Invalid coin pulse or inoperative coin sensor. Check coin drop area and remove obstructions. If error persists, tampering may have occurred. Evaluate security procedures.
<i>E id</i>	Board ID	Incorrect replacement control. Replace user control or output board with the correct part.
<i>E d5</i>	Brownout/Voltage Configuration	Unexpected supply voltage. Check the harness connections between the user control and the output board. If the user control was replaced, set dip switch #1 to the same setting as the previous control. If reworking the machine to use a different voltage supply, the dip switch #1 setting may need to be changed. If the dip switch #1 setting is changed, power down, power up and try again.
<i>E nr</i>	Drive/Output Board Not Ready	Hardware failure. Try cycling power to machine before replacing output board.
<i>E b5</i>	Drive/Output Board Shorted	Hardware failure. Try cycling power to machine before replacing output board.
<i>En</i>	Machine ID Errors	
<i>En 31</i>	Product Byte #1 Mis-Match	Product family does not match between the Machine ID Control and Front End Control. Replace Machine ID Control with one meant for current Front End Control platform.
<i>En 32</i>	Product Byte #2 Mis-Match	Machine type does not match between the Machine ID Control and Front End Control (frontload washer vs. dryer). Replace Machine ID Control and/or front end control with one meant for current machine type.
<i>En 33</i>	Product Byte #3 Mis-Match	Control level does not match between the Machine ID Control and Front End Control (A4 vs. A2). Replace Machine ID Control with a properly configured A level for the control being attached. Use Factory Test Procedure to determine front end control's control level.
<i>En 39</i>	Corrupted Data on Machine ID Control	Try cycling power to machine. If error continues, check for damage to Machine ID Control and harness and/or replace Machine ID Control with a correctly configured Machine ID Control.

*Table continues...*

<b>Error Codes</b>		
<b>Display</b>	<b>Description</b>	<b>Cause/Corrective Action</b>
<i>E n 3E</i>	Machine control cannot be configured with the Machine ID Control in the machine	Try cycling power to machine. If error continues, check for damage to Machine ID Control and harness and/or replace Machine ID Control with a correctly configured Machine ID Control.
<i>E n 3F</i>	Cannot communicate with the Machine ID Control	Try cycling power to machine. If error continues, check for damage to Machine ID Control and harness and/or replace Machine ID Control with a correctly configured Machine ID Control.
<i>E Co</i>	Drive/Output Board Communication Error	Communication failure. Power down, power up and try again. If error persists, check connection between user control and output board, or try replacing the user control or the output board.
<i>E dr</i>	Drain Error	If the control has the drain error enabled the control will enter Machine Error Mode when the water height is not below the empty level, after attempting to drain for the programmable time (default 15 minutes). In the event of a drain error, the control will turn off all outputs and turn on the Machine Error Tone for 15 seconds.
<i>E 5d</i>	Slow Drain Error	If a slow drain is detected in the Drain step of a running cycle, the machine control will light the right-most decimal point. The decimal point will remain illuminated after the slow drain error display has expired, to draw the attention of the owner or attendant. The decimal point can be cleared by pressing the START keypad 3 times in a period of 5 seconds, or by cycling the power to the machine.
<i>E 5uds</i>	Suds Lock Error	In the spin steps, if the control determines that there are suds in the machine after running all programmed Suds Routines, it will display a Suds Lock Error at the end of the cycle after the door is opened. The control will continue showing this error code until any key has been pressed or for one minute.
<i>E Ld</i>	Water Leak Drain Error	Error will display if there is a leak after the door is opened at the End of Cycle for 1 minute. Clears after 1 minute or until a key is pressed. If the water level has dropped more than an acceptable amount in a during a water leak drain check, the control will save a water leak drain error status and will continue the machine cycle. Immediately upon detecting the error the right-most decimal point will be lit. This lit decimal point can be cleared by pressing the START keypad 3 times in a period of 5 seconds or by cycling the power to the machine.
<i>E nFLo</i>	No Water Flow Error	If the control does not reach a water level of 4 inches within the programmed time it may mean the hose to the pressure sensor has a leak or no water is flowing into the machine. The control will enter Machine Error mode. The control will first drain for 90 seconds and then turn off all outputs and turn on the Machine Error Tone for 15 seconds. To clear this error one of the following must occur: the machine must be powered down, the Clear Fatal Error Keys must be pressed, or a Clear Fatal Error Network command must be sent.
<i>E oF</i>	Overflow Error	The machine must be powered down, the Clear Fatal Error Keys must be pressed, or a Clear Fatal Error Network command must be sent. This error is triggered when an unsafe high water level is detected in the machine and water is unable to drain.

*Table continues...*

Error Codes		
Display	Description	Cause/Corrective Action
<b>E P5</b>	Pressure Sensor Error	If the control does not detect a valid water level sensor input for thirty (30) seconds, or if the Max (Overflow) Fill Level in the control is set to 0 while in Run Mode, Factory Test Mode, or Overflow Mode, the control will enter Machine Error Mode. The control will first drain for thirty (30) seconds to get out any water, and unlock the door. To clear this error one of the following must occur: the machine must be powered down, the Clear Fatal Error Keys must be pressed, or a Clear Fatal Error Network command must be sent.
<b>E Er</b>	Trim Error	The machine must be powered down, the Clear Fatal Error Keys must be pressed or a Clear Fatal Error Network command must be sent.
<b>E bELt</b>	Broken Belt Error	If a broken belt is ever detected by the control, the control will show error this error code. To clear this error one of the following must occur: the machine must be powered down, the Clear Fatal Error Keys must be pressed, or a Clear Fatal Error Network command must be sent.
<b>E LF</b>	Water Leak Fill Error	If the water level has raised more than an acceptable amount in a during a water leak check, the control will save a water leak error status and will continue the machine cycle. Immediately upon detecting the error the right-most decimal point will be lit. This lit decimal point can be cleared by pressing the START keypad 3 times in a period of 5 seconds or by cycling the power to the machine.
Display is dim		Look for loose pins and damaged wires on harness from user control to drive board.
<b>E d</b>	Drive Board Errors	
<b>E d 10</b>	Voltage Select Error	Wrong Input Voltage seen at drive board 120V vs 240V. Dip switch 1 on FEC set wrong, or possibly water on drive board (let drive dry out and determine cause of water). Unpower to clear error. Replace drive board if error persists.
<b>E d 12</b>	Over Voltage AC-Main Input Error	Machine voltage is too high, check supply voltage to the machine and verify that it is within machine specifications. Unpower to clear error. Replace drive board if error persists.
<b>E d 13</b>	Power Fail Dangerous Error	The Neutral Line power input to the machine was seen out of range. Unpower to clear error. Check for damage in the power supply harness. Replace power supply harness or drive board if error persists.
<b>E d 21</b>	Over Voltage DC Bus Error	Unpower to clear error. Check voltage input to machine. If it happens only at start of spin, replace motor. Replace drive board if error persists.
<b>E d 22</b>	Over Motor Temperature Error	Motor temperature is detected to be too high. Check that drum spins freely when empty. Check for overloading of machine. Check motor harness for damage. Reduce agitation time and duty cycle if rotate/pause times are very short and programmable. Unpower to clear error. Replace drive board if error persists.
<b>E d 23</b>	Fatal IPM Over Current Shunt Error	Check that drum and motor spins freely. Unpower to clear error. Check the motor phase windings. Continuity should be uniform between phases L1 and L2, L2 and L3, L1 and L3. Replace motor if not uniform. Replace drive board if error persists.

*Table continues...*

<b>Error Codes</b>		
<b>Display</b>	<b>Description</b>	<b>Cause/Corrective Action</b>
<i>E d 24</i>	Fatal I2T Hardware Over Current Error	Check that drum and motor spins freely. Rotor may be locked up. Check the motor phase windings. Continuity should be uniform between phases L1 and L2, L2 and L3, L1 and L3. Replace motor if not uniform. Unpower to clear error. Replace drive board if error persists.
<i>E d 25</i>	IPM Over Temperature Error	IPM temperature is detected to be too high. Check that drum spins freely when empty, check for overloading of machine, reduce agitation time, and duty cycle if rotate/pause times are very short and programmable. Unpower to clear error. Check for lint build-up on heat sink on drive board. Replace drive board if error persists.
<i>E d 29</i>	Motor Not Connected Error	The motor or one of its electrical phases is not connected. Check that the harness from the motor to the drive board is fully plugged in on both ends and that there is no damage to the motor harness. Make sure to push in the motor harness on both ends just in case it is a little loose and not fully inserted. If the harness looks fine and the error still occurs, try replacing the drive board or harness. Unpower to clear error.
<i>E d 44</i>	Overcurrent Shunt Detection Circuit Fail Error	Hardware failure. Unpower to clear error. Replace drive board if error persists.
<i>E d 45</i>	Door Lock Pin HW On/Off Fail Error	Hardware failure. Unpower to clear error. Replace drive board if error persists.
<i>E d 46</i>	Heater Pin HW On/Off Fail	Hardware failure. Unpower to clear error. Replace drive board if error persists.
<i>E d 47</i>	Hot Valve Pin HW On/Off Fail	Hardware failure. Unpower to clear error. Replace drive board if error persists.
<i>E d 48</i>	Cold Valve Pin HW On/Off Fail	Hardware failure. Unpower to clear error. Replace drive board if error persists.
<i>E d 49</i>	Detergent Valve Pin HW On/Off Fail	Hardware failure. Unpower to clear error. Replace drive board if error persists.
<i>E d 50</i>	Softener Valve Pin HW On/Off Fail	Hardware failure. Unpower to clear error. Replace drive board if error persists.
<i>E d 51</i>	Inrush Pin HW On/Off Fail	Hardware failure. Unpower to clear error. Replace drive board if error persists.
<i>E d 52</i>	Voltage Doubler Pin HW On/Off Fail	Hardware failure. Unpower to clear error. Replace drive board if error persists.
<i>E d 53</i>	Door Lock Select Voltage Pin HW On/Off Fail	Hardware failure. Unpower to clear error. Replace drive board if error persists.

*Table continues...*

<b>Error Codes</b>		
<b>Display</b>	<b>Description</b>	<b>Cause/Corrective Action</b>
<i>E d 54</i>	Pump Pin HW On/Off Fail	Hardware failure. Unpower to clear error. Replace drive board if error persists.
<i>E d 55</i>	Fatal NTC Short Error	Check heater thermistor and thermistor wiring for damage. Unpower to clear error. Replace drive board if error persists.
<i>E d 56</i>	Fatal NTC Open Error	Check heater thermistor and thermistor wiring for damage. Unpower to clear error. Replace drive board if error persists.
<i>E d 63</i>	Fatal IPM Temperature Short Error	Hardware failure. Unpower to clear error. Replace drive board if error persists.
<i>E d 64</i>	Fatal IPM Temperature Open Error	Hardware failure. Unpower to clear error. Replace drive board if error persists.

# Rapid Advance Feature

This feature allows the user to quickly advance through an active cycle or advance into a cycle from the Ready Mode. This feature is useful when tests must be performed immediately on a machine currently in an active cycle. In this case, the user can quickly advance through the cycle to the Ready Mode. At this point, the user can perform the required tests and then return the machine to the active cycle.

## How to Enter Rapid Advance

1. Control must be in Manual Mode. Refer to *How to Enter the Manual Mode*.
2. Press the DELICATES/BULKY (Λ) or the COLD (V) keypad to scroll through the programmable options until **RAP ID** appears in the display.
3. Press the START (enter) keypad. The display will show **PUSH** then **START** followed by the cycle time and the START (enter) keypad LED will flash.
4. Press the START (enter) keypad to start cycle or, if already in an active cycle, pressing START (enter) keypad will advance to the next cycle step.

**NOTE: Door must be closed to start cycle.**

5. Continue pressing the START (enter) keypad until the cycle is completed.

**NOTE: The Rapid Advance option must be turned on for Rapid Advance to work.**

## How to Exit Rapid Advance Feature

Advance through the cycle until reaching the Ready Mode.

# Clear Vend Feature

The Clear Vend feature allows the owner to clear a control which is in the middle of satisfying the initial vend price, and set it back to the ready mode.

**NOTE: The Clear Vend Feature does not work with Additional Vend Mode or Additional Cycle Top-Off.**

## How to Clear Vend

1. Open the service door. Refer to Opening the Service Door section.
2. While pressing and holding the MEDIUM modifier keypad with one hand, press the NORMAL cycle keypad with the other hand. The control will reset to the Ready Mode and clear out the current vend that has been entered.



# Power Fail Recovery

The Power Fail Recovery feature allows the cycle status to be saved in memory in the event of a power failure.

If the power failure lasted less than 5 seconds and the door is locked, the cycle will resume without requiring the user to press the START (enter) keypad to restart.

If the power failure lasted longer than 5 seconds, the Power Fail Reset option is turned **on**, and the duration of the power failure is less than or equal to the time programmed in the Power Fail Reset option, the door is unlocked and the START (enter) keypad will flash until it is pressed and the cycle will restart from the point it left off.

If the power failure lasted longer than 5 seconds and the Power Fail Reset option is turned **off**, the door is unlocked and the START (enter) keypad will flash one second on and one second off until it is pressed. The cycle will restart from the point it left off when START (enter) is pressed.

If the power failure lasted longer than 5 seconds, lasted longer than the time programmed in the Power Fail Reset option, and the Power Fail Reset option is turned **on**, the control will reset the cycle and lose all vending entered for the cycle.

# Communications Mode

## Infra-red Communications

The Infra-red Communications feature allows the washer control to communicate with an external device. The washer control can be programmed and have its data read without using the keypad. It may also be used to start and stop various diagnostic tests.

### How to Begin Communications with an External Device

The control will go blank and the display will show *-C-* until the communication is complete. If an error occurs that terminates communication, the display will show *E! HH* (*HH* represents the error code).

**NOTE: The Infra-red Communications option must be turned on.**

## Card Reader Communications - Card Models Only

The Card Reader Communications feature allows the washer control to communicate with the card reader. The washer control can be programmed for a limited number of options and have its data read without using the keypad.

## Network Communications

The Network Communications feature allows the washer control to communicate with a network. The washer control can be programmed and have its data read without using the keypad.

# Default Cycle Time

The cycle times listed are the default cycle times programmed at the factory. The cycles can be made longer or shorter by reprogramming the fill/agitate times. Refer to *How to Enter Cycle Programming CyCLE*- to change these times.

Normal is the default cycle.

Description	Step Number	Step Type	Step Time (Minutes:Seconds)
Initial Drain	1	Extract	0:10
Prewash (Active with Mod1 only and using wetting fill)	2	Fill	2:30
	3	Supply	0:30
	4	Agitate	1:30
	5	Cooldown	-
	6	Extract	2:00
Wash (Using wetting fill)	7	Fill	2:30
	8	Supply Detergent/Bleach; ES1, ES2	0:30
	9	Agitate	Normal = 3:00 Perm Press = 2:30 Delicate = 2:00
	10	Cooldown	-
	11	Extract	Normal & Perm Press = 4:20 Delicate = 4:05
Rinse 1	12	Fill	2:00
	13	Agitate	0:35
	14	Extract	Normal & Perm Press = 4:20 Delicate = 4:05
Rinse 2 (Active with Mod2 only)	15	Fill	2:00
	16	Agitate	0:35
	17	Extract	Normal & Perm Press = 4:20 Delicate = 4:05
Rinse 3 (Disabled)	18	Fill	2:00
	19	Agitate	0:35
	20	Extract	Normal & Perm Press = 4:20 Delicate = 4:05

*Table continues...*

Default Cycle Time

Description	Step Number	Step Type	Step Time (Minutes:Seconds)
Rinse 4	21	Fill	2:00
	22	Supply Softener; ES3, ES4	0:30
	23	Agitate	0:35
Final Extract	25	Extract	Normal = 9:50 Perm Press = 8:20 Delicate = 7:20
Shakeout	25	Agitate	0:40
Total Time			Normal = 30:00 Perm Press = 28:00 Delicate = 26:00